



**Powerware® 9125 Two-in-One UPS
700–2000 VA
User's Guide**

US Patent 6,160,722

Requesting a Declaration of Conformity

Units that are labeled with a CE mark comply with the following harmonized standards and EU directives:

- Harmonized Standards: EN 62040-1-1 and EN 50091-2; IEC 60950-1
- EU Directives: 73/23/EEC, Council Directive on equipment designed for use within certain voltage limits
93/68/EEC, Amending Directive 73/23/EEC
89/336/EEC, Council Directive relating to electromagnetic compatibility
92/31/EEC, Amending Directive 89/336/EEC relating to EMC

The EC Declaration of Conformity is available upon request for products with a CE mark. For copies of the EC Declaration of Conformity, contact:

Eaton Power Quality Oy
Koskelontie 13
FIN-02920 Espoo
Finland
Phone: +358-9-452 661
Fax: +358-9-452 665 68

Powerware, ABM, X-Slot, LanSafe, and FERRUPS are registered trademarks and ConnectUPS is a trademark of Eaton Electrical Inc. Modbus is a registered trademark of Modicon. AS/400 is a registered trademark of International Business Machines Corp.

©Copyright 1999–2006 Eaton Corporation, Raleigh, NC, USA. All rights reserved. No part of this document may be reproduced in any way without the express written approval of Eaton Corporation.

Class B EMC Statements

FCC Part 15

NOTE This equipment has been tested and found to comply with the limits for a Class B digital device, pursuant to part 15 of the FCC Rules. These limits are designed to provide reasonable protection against harmful interference in a residential installation. This equipment generates, uses and can radiate radio frequency energy and, if not installed and used in accordance with the instructions, may cause harmful interference to radio communications. However, there is no guarantee that interference will not occur in a particular installation. If this equipment does cause harmful interference to radio or television reception, which can be determined by turning the equipment off and on, the user is encouraged to try to correct the interference by one or more of the following measures:

- Reorient or relocate the receiving antenna.
- Increase the separation between the equipment and the receiver.
- Connect the equipment into an outlet on a circuit different from that to which the receiver is connected.
- Consult the dealer or an experienced radio/TV technician for help.

ICES-003

This Class B Interference Causing Equipment meets all requirements of the Canadian Interference Causing Equipment Regulations ICES-003.

Cet appareil numérique de la classe B respecte toutes les exigences du Règlement sur le matériel brouilleur du Canada.

VCCI Notice

この装置は、情報処理装置等電波障害自主規制協議会（VCCI）の基準に基づくクラスB情報技術装置です。この装置は、家庭環境で使用することを目的としていますが、この装置がラジオやテレビジョン受信機に近接して使用されると、受信障害を引き起こすことがあります。
取扱説明書に従って正しい取り扱いをして下さい。

Special Symbols

The following are examples of symbols used on the UPS or accessories to alert you to important information:



RISK OF ELECTRIC SHOCK - Indicates that a risk of electric shock is present and the associated warning should be observed.



CAUTION: REFER TO OPERATOR'S MANUAL - Refer to your operator's manual for additional information, such as important operating and maintenance instructions.



RJ-45 RECEPTACLE - For 230V models only: this receptacle provides network interface connections. Do not plug telephone or telecommunications equipment into this receptacle.



This symbol indicates that you should not discard the UPS or the UPS batteries in the trash. This product contains sealed, lead-acid batteries and must be disposed of properly. For more information, contact your local recycling/reuse or hazardous waste center.



This symbol indicates that you should not discard waste electrical or electronic equipment (WEEE) in the trash. For proper disposal, contact your local recycling/reuse or hazardous waste center.

Table of Contents

- 1 Introduction 1**
- 2 Safety Warnings 3**
- 3 Installation 19**
 - Inspecting the Equipment 19
 - Connecting the UPS Internal Battery 20
 - UPS Setup 21
 - Rack-Mount Setup 21
 - Tower Setup 22
 - Installing the UPS 25
 - Remote Emergency Power-off Installation 27
 - UPS Rear Panels 29
- 4 Operation 31**
 - Turning the UPS On 31
 - Starting the UPS on Battery 31
 - Turning the UPS Off 32
 - Initiating the Self-Test 32
 - Operating Modes 33
 - Normal Mode 34
 - Battery Mode 35
 - Bypass Mode 36
 - Standby Mode 36
- 5 Configuration 37**
- 6 Additional UPS Features 41**
 - X-Slot Cards 41
 - Single-Port Card 42
 - USB Card 44
 - Network Transient Protector 45
 - Load Segments 46

7	UPS Maintenance	47
	UPS and Battery Care	47
	Storing the UPS and Batteries	47
	When to Replace Batteries	48
	Replacing Batteries	48
	How to Replace Internal Batteries	49
	How to Replace Extended Battery Modules	50
	Testing New Batteries	52
	Recycling the Used Battery or UPS	52
8	Specifications	53
9	Troubleshooting	57
	Audible Alarms and UPS Conditions	57
	Silencing an Audible Alarm	57
	Service and Support	60
10	Warranty	61
	Two-Year Limited Warranty (US and Canada)	61
	Ten-Year Pro-Rated Limited Warranty (US and Canada)	63
	Load Protection Guarantee (US and Canada)	65

Chapter 1 Introduction

The Powerware® 9125 uninterruptible power system (UPS) protects your sensitive electronic equipment from the most common power problems including power failures, power sags, power surges, brownouts, line noise, high voltage spikes, frequency variations, switching transients, and harmonic distortion.

Power outages can occur when you least expect it and power quality can be erratic. These power problems have the potential to corrupt critical data, destroy unsaved work sessions, and damage hardware — causing hours of lost productivity and expensive repairs.

With the Powerware 9125, you can safely eliminate the effects of power disturbances and guard the integrity of your equipment. Figure 1 shows the Powerware 9125 UPS with an optional Extended Battery Module (EBM).

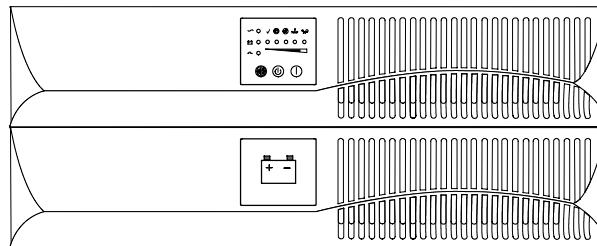

Figure 1. The Powerware 9125 UPS with Optional EBM

Providing outstanding performance and reliability, the Powerware 9125's unique benefits include the following:

- Online UPS design with pure sine wave output. The UPS filters and regulates incoming AC power and provides consistent power to your equipment without draining the battery.
- 2U rack height that conserves valuable rack space.
- Two-in-one form factor for using the UPS in a rack-mount configuration or as a standalone cabinet.
- ABM® technology that uses advanced battery management to increase battery service life, optimize recharge time, and provide a warning before the end of useful battery life.
- Hours of extended runtime with up to four EBMs.

- Start-on-battery capability for powering up the UPS even if utility power is not available.
- Hot-swappable batteries that simplify maintenance by allowing you to replace batteries safely without powering down the critical load.
- Emergency shutdown control through the remote emergency power-off (REPO) port.
- Optional X-Slot® cards with enhanced communication capabilities for increased power protection and control.
- Network transient protector that guards your network communications equipment from surges. Low voltage models can also protect modems, fax machines, or other telecommunications equipment.
- Advanced power management with the Software Suite CD for graceful shutdowns and power monitoring.
- Sequential shutdown and load management through separate receptacle groups, called load segments.
- Backed by worldwide agency approvals.

Chapter 2 Safety Warnings

IMPORTANT SAFETY INSTRUCTIONS SAVE THESE INSTRUCTIONS

This manual contains important instructions that you should follow during installation and maintenance of the UPS and batteries. Please read all instructions before operating the equipment and save this manual for future reference.

DANGER



This UPS contains **LETHAL VOLTAGES**. All repairs and service should be performed by **AUTHORIZED SERVICE PERSONNEL ONLY**. There are **NO USER SERVICEABLE PARTS** inside the UPS.

WARNING



- This UPS contains its own energy source (batteries). The output receptacles may carry live voltage even when the UPS is not connected to an AC supply.
 - For 220–240V models, the output receptacles may remain electrically live. If the input power source in your application is wired line-to-neutral (as in most European applications), the voltage to the output receptacles is 0V. With line-to-line input wiring, the voltage to the output receptacles is 110–120V (measured from line-to-ground or line-to-neutral, depending on the UPS wiring).
 - Do not remove or unplug the input cord when the UPS is turned on. This removes the safety ground from the UPS and the equipment connected to the UPS.
 - To reduce the risk of fire or electric shock, install this UPS in a temperature and humidity controlled, indoor environment, free of conductive contaminants. Ambient temperature must not exceed 40°C (104°F). Do not operate near water or excessive humidity (95% maximum).
 - To comply with international standards and wiring regulations, the total equipment connected to the output of this UPS must not have an earth leakage current greater than 1.5 milliamperes.
-



CAUTION

- Batteries can present a risk of electrical shock or burn from high short-circuit current. Observe proper precautions. Servicing should be performed by qualified service personnel knowledgeable of batteries and required precautions. Keep unauthorized personnel away from batteries.
- Proper disposal of batteries is required. Refer to your local codes for disposal requirements.
- Never dispose of batteries in a fire. Batteries may explode when exposed to flame.

Sikkerhedsanvisninger

VIGTIGE SIKKERHEDSANVISNINGER GEM DISSE ANVISNINGER

Denne manual indeholder vigtige instruktioner, som skal følges under installation og vedligeholdelse af UPS'en og batterierne. Læs venligst alle instruktioner inden betjening af udstyret og gem denne manual mhp. fremtidige opslag.



FARE

Denne UPS indeholder LIVSFARLIG HØJSPÆNDING. Alle reparationer og vedligeholdelse bør kun udføres af en AUTORISERET SERVICE TEKNIKER. Ingen af UPS'ens indvendige dele kan repareres af brugeren.



ADVARSEL!

- Denne UPS indeholder sin egen energikilde (batterier). Udgangsstikkene kan endog være strømførende, når UPS'en ikke er koblet til en vekselstrømsforsyning.
- På 220–240V-modeller kan udgangsstikkene være strømførende. Hvis ledningsføringen til indgangsstrømkilden på din enhed er fase-til-neutral (som på de fleste europæiske enheder), er spændingen til udgangsstikkene 0V. Med en fase-til-fase indgangsledningsføring er spændingen til udgangsstikkene 110–120V (målt fra fase-til-jord eller fase-til-neutral, afhængig af UPS-ledningsføringen).
- Netledningen må ikke fjernes og stikket må ikke trækkes ud, mens UPS'en er tændt. Dette fjerner sikkerhedsjorden fra UPS'en og fra det udstyr, der er sat til.
- Installér denne UPS i et temperatur- og fugtighedskontrolleret indendørsmiljø, frit for ledende forureningsstoffer for at formindske risikoen for brand og elektrisk stød. Rumtemperaturen må ikke overstige 40°C. UPS'en bør ikke betjenes nær vand eller høj fugtighed (maksimalt 95%).
- I overensstemmelse med internationale normer og bestemmelser for el-installation må det udstyr, der er forbundet til udgangen af denne UPS, tilsammen ikke overskride en jordafdelingsspænding på mere end 1,5 milliamperere.



ADVARSEL

- Batterierne kan give risiko for elektrisk stød eller brandsår forårsaget af høj kortslutningsstrøm. Overhold gældende forsigtighedsregler. Servicing skal udføres af kvalificeret servicepersonale med kendskab til batterier og gældende forsigtighedsregler. Hold uautoriseret personale væk fra batterierne.
- Korrekt bortskaffelse af batterier er påkrævet. Overhold gældende lokale regler for bortskaffelsesprocedurer.
- Skaf dig aldrig af med batterierne ved at brænde dem. Batterierne kan eksplodere ved åben ild.

Belangrijke Veiligheidsinstructies

BELANGRIJKE VEILIGHEIDSINSTRUCTIES BEWAAR DEZE INSTRUCTIES

Deze handleiding bevat belangrijke instructies die u dient te volgen tijdens de installatie en het onderhoud van de UPS en de accu's. Lees alle instructies voordat u de apparatuur in bedrijf neemt en bewaar deze handleiding als naslagwerk.



GEVAAR

Deze UPS bevat LEVENSGEVAARLIJKE ELEKTRISCHE SPANNING. Alle reparaties en onderhoud dienen UITSLUITEND DOOR ERKEND SERVICEPERSONEEL te worden uitgevoerd. Er bevinden zich GEEN ONDERDELEN in de UPS die DOOR DE GEBRUIKER kunnen worden GEREPAREERD.



WAARSCHUWING

- Deze UPS bevat een eigen energiebron (batterijen). De uitgangcontactdoos kan onder spanning staan, zelfs wanneer de UPS niet is aangesloten op de netspanning.
- Bij de modellen van 220–240V kan de uitgangcontactdoos onder spanning blijven staan. Als de bedrading van de ingangsspanningsbron in uw systeem loopt van fase naar aarde (zoals bij de meeste Europese systemen) dan bedraagt de spanning op de uitgangcontactdozen 0 V. Als de ingangsbedrading loopt van fase naar fase dan bedraagt de spanning op de uitgangcontactdozen 110–120V (gemeten tussen fase en aarde of tussen fase en neutraal, afhankelijk van de UPS-bedrading).
- Verwijder de ingang snoer niet of haal de stekker van de ingang snoer er niet uit terwijl de UPS aan staat. Hierdoor zou de UPS en uw aangesloten apparatuur geen aardebeveiliging meer hebben.

- Teneinde de kans op brand of elektrische schok te verminderen dient deze UPS in een gebouw met temperatuur- en vochtigheidsregeling te worden geïnstalleerd, waar geen geleidende verontreinigingen aanwezig zijn. De omgevingstemperatuur mag 40°C niet overschrijden. Niet gebruiken in de buurt van water of bij zeer hoge vochtigheid (max. 95%).
 - Om aan de internationale normen en bedradingsvoorschriften te voldoen mag de gehele apparatuur die op de uitgang van deze UPS is aangesloten, geen aardlekstroom van meer dan 1,5 milliampère hebben.
-



OPGELET

- Batterijen leveren gevaar op voor elektrische schokken en kunnen brandwonden veroorzaken door een grote kortsluitstroom. Neem de juiste voorzorgsmaatregelen in acht. Het onderhoud moet worden uitgevoerd door bevoegde onderhoudsmonteurs die verstand hebben van accu's en op de hoogte zijn van de vereiste voorzorgsmaatregelen. Houd onbevoegden uit de buurt van de accu's.
 - De batterijen moeten op de juiste wijze worden opgeruimd. Raadpleeg hiervoor uw plaatselijke voorschriften.
 - Nooit batterijen in het vuur gooien. De batterijen kunnen ontploffen.
-

Tarkeita Turvaohjeita

TÄRKEITÄ TURVAOHJEITA - SUOMI SÄILYTÄ NÄMÄ OHJEET

Tämä käyttöohje sisältää tärkeitä ohjeita, joita on noudatettava UPS-virtalähteen ja akkujen asennuksen ja huollon yhteydessä. Lue kaikki ohjeet ennen laitteiston käyttöä ja säilytä ohje myöhempää tarvetta varten.

VAARA



Tämä UPS sisältää HENGENVAARALLISIA JÄNNITTEITÄ. Kaikki korjaukset ja huollot on jätettävä VAIN VALTUUTETUN HUOLTOHENKILÖN TOIMEKSI. UPS ei sisällä MITÄÄN KÄYTTÄJÄN HUOLLETTAVIA OSIA.

VAROITUS



- Tässä UPS-virtalähteessä on oma energianlähde (akut). Lähtövastakkeissa voi olla jännite, vaikka UPS-virtalähdettä ei ole kytketty verkkovirtaan.
- 220–240V -malleissa lähtövastakkeissa voi säilyä jännite. Jos sovelluksen tulovirtalähde on johdotettu linjasta neutraaliin (kuten useimmissa eurooppalaisissa sovelluksissa) lähtövastakkeiden jännite on 0 V. Linjasta linjaan –tulojohdotuksessa lähtövastakkeiden jännite on 110–120V (mitataan linjasta maahan tai linjasta neutraaliin, UPS-virtalähteen johdotuksesta riippuen).
- Älä poista tai irrota sisääntulojohtoa, kun UPS on kytkettynä. Tämä poistaa turvamaadoituksen UPS-laitteesta ja siihen liitetystä laitteistosta.
- Vähentääksesi tulipalon ja sähköiskun vaaraa asenna tämä UPS sisätiloihin, joissa lämpötila ja kosteus on säädettävissä ja joissa ei ole virtaa johtavia epäpuhtauksia. Ympäristön lämpötila ei saa ylittää 40 °C. Älä käytä lähellä vettä ja vältä kosteita tiloja (95 % maksimi).
- Kansainväliset normit ja johdotusmääräykset vaativat, että kaikkien tämän UPS-laitteen ulostulokytentöjen yhteinen maavuotovirta ei ylitä 1,5 milliampeeria (mA).

VARO



- Akut voivat aiheuttaa sähköiskun tai palovammojen vaaran johtuen suuresta oikosulkuvirrasta. Noudata kaikkia asianmukaisia varotoimia. Laitteen saa huoltaa vain ammattitaitoinen huoltohenkilökunta, joka tuntee akut ja niihin liittyvät varotoimet. Älä päästä valtuuttamatonta henkilöstöä lähelle akkuja.
- Akusto täytyy hävittää säädösten mukaisella tavalla. Noudata paikallisia määräyksiä.
- Älä koskaan heitä akkuja tuleen. Ne voivat räjähtää.

Consignes de sécurité

CONSIGNES DE SÉCURITÉ IMPORTANTES CONSERVER CES INSTRUCTIONS

Ce manuel comporte des instructions importantes que vous êtes invité à suivre lors de toute procédure d'installation et de maintenance des batteries et de l'onduleur. Veuillez consulter entièrement ces instructions avant de faire fonctionner l'équipement et conserver ce manuel afin de pouvoir vous y reporter ultérieurement.

DANGER!



Cet onduleur contient des TENSIONS MORTELLES. Toute opération d'entretien et de réparation doit être EXCLUSIVEMENT CONFIEE A UN PERSONNEL QUALIFIE AGRÉÉ. AUCUNE PIÈCE RÉPARABLE PAR L'UTILISATEUR ne se trouve dans l'onduleur.

AVERTISSEMENT!



- Cette onduleur possède sa propre source d'alimentation (batteries). Il est possible que les prises de sortie soient sous tension même lorsque l'onduleur n'est pas connectée à une alimentation CA.
- En ce qui concerne les modèles 220–240 V, il est possible que les prises de sortie restent sous tension. Si la source d'alimentation de votre application est câblée phase et neutre (comme dans la majorité des applications européennes), la tension vers les prises de sortie est de 0 V. Avec un câblage d'entrée phase à phase, la tension vers les prises de sortie est de 110–120 V (mesurée entre phase et terre ou phase et neutre suivant le câblage de l'onduleur).
- Ne pas retirer le cordon d'alimentation lorsque l'onduleur est sous tension sous peine de supprimer la mise à la terre de l'onduleur et du matériel connecté.
- Pour réduire les risques d'incendie et de décharge électrique, installer l'onduleur uniquement à l'intérieur, dans un lieu dépourvu de matériaux conducteurs, où la température et l'humidité ambiantes sont contrôlées. La température ambiante ne doit pas dépasser 40 °C. Ne pas utiliser à proximité d'eau ou dans une atmosphère excessivement humide (95 % maximum).
- Afin d'être conforme aux normes et règlements internationaux de câblage, le courant de fuite à la terre de la totalité du matériel branché sur la sortie de l'onduleur ne doit pas dépasser 1,5 mA.



ATTENTION!

- Les batteries peuvent présenter un risque de choc électrique ou de brûlure provenant d'un courant de court-circuit haute intensité. Observez les précautions appropriées. L'entretien doit être réalisé par du personnel qualifié connaissant bien les batteries et les précautions nécessaires. N'autorisez aucun personnel non qualifié à manipuler les batteries.
- Une mise au rebut réglementaire des batteries est obligatoire. Consulter les règlements en vigueur dans votre localité.
- Ne jamais jeter les batteries au feu. L'exposition aux flammes risque de les faire exploser.

Sicherheitswarnungen

WICHTIGE SICHERHEITSANWEISUNGEN AUFBEWAREN

Dieses Handbuch enthält wichtige Anweisungen, die Sie während der Installation und Wartung des USV (Unterbrechungsfreies Stromversorgungssystem) und der Batterien befolgen müssen. Bitte lesen Sie alle Anweisungen des Handbuches bevor sie mit dem Gerät arbeiten. Bewahren Sie das Handbuch zum Nachlesen auf.



WARNUNG

Die USV führt lebensgefährliche Spannungen. Alle Reparatur- und Wartungsarbeiten sollten nur von Kundendienstfachleuten durchgeführt werden. Die USV enthält keine vom Benutzer zu wartenden Komponenten.



ACHTUNG

- Dieses USV (Unterbrechungsfreies Stromversorgungssystem) enthält eine eigene Energiequelle (Batterien). Die Ausgangssteckdosen können Spannung führen, auch wenn das USV nicht an eine Wechselstromquelle angeschlossen ist.
- Bei Modellen mit 220–240 Volt können die Ausgangssteckverbinder stromführend bleiben. Wenn die Eingangsstromquelle in Ihrer Anlage mit Masseleitung verkabelt ist (wie in den meisten europäischen Anlagen), beträgt die Spannung an den Ausgangssteckverbindern 0 Volt. Bei einer Verkabelung mit Außenleitern beträgt die Spannung an den Ausgangssteckverbindern 110–120 Volt (gemessen von Leitung zu Masse oder Leitung zu Masseleiter, abhängig von der USV-Verkabelung).
- Das Eingangskabel nicht entfernen oder abziehen, während die USV eingeschaltet ist, weil hierdurch die Sicherheitserdung von der USV und den daran angeschlossenen Geräten entfernt wird.

- Um die Brand- oder Elektroschockgefahr zu verringern, diese USV nur in Gebäuden mit kontrollierter Temperatur und Luftfeuchtigkeit installieren, in denen keine leitenden Schmutzstoffen vorhanden sind. Die Umgebungstemperatur darf 40°C nicht übersteigen. Die USV nicht in der Nähe von Wasser oder in extrem hoher Luftfeuchtigkeit (max. 95 %) betreiben.
- Um internationale Normen und Verdrahtungsvorschriften zu erfüllen, dürfen die an den Ausgang dieser USV angeschlossenen Geräte zusammen einen Erdableitstrom von insgesamt 1,5 Milliampere nicht überschreiten.

VORSICHT!



- Batterien können das Risiko eines elektrischen Schlags bergen oder durch hohen Kurzschlussstrom in Brand geraten. Die richtigen Vorsichtsmaßnahmen beachten. Die Wartung muss von qualifiziertem Wartungspersonal durchgeführt werden, das im Umgang mit Batterien geübt ist und über gute Kenntnisse der erforderlichen Vorsichtsmaßnahmen verfügt. Nicht autorisiertes Personal von Batterien fern halten.
- Die Batterien müssen ordnungsgemäß entsorgt werden. Hierbei sind die örtlichen Bestimmungen zu beachten.
- Batterien niemals verbrennen, da sie explodieren können.

Avvisi di sicurezza

IMPORTANTI ISTRUZIONI DI SICUREZZA CONSERVARE QUESTE ISTRUZIONI

Il presente manuale contiene importanti istruzioni da seguire durante l'installazione e la manutenzione dell'UPS e delle batterie. Leggere integralmente le istruzioni prima di utilizzare l'apparecchiatura e conservare il presente manuale per futuro riferimento.

PERICOLO



La TENSIONE contenuta in questo gruppo statico di continuità è LETALE. Tutte le operazioni di riparazione e di manutenzione devono essere effettuate ESCLUSIVAMENTE DA PERSONALE TECNICO AUTORIZZATO. All'interno del gruppo statico di continuità NON vi sono PARTI RIPARABILI DALL'UTENTE.

AVVERTENZA



- L'UPS contiene la propria fonte di energia (batterie). Le prese d'uscita possono essere sotto tensione anche quando l'UPS non è collegato all'alimentazione elettrica CA.
- Nei modelli da 220–240 V è possibile che le prese d'uscita rimangano sotto tensione. Se la fonte di alimentazione in entrata dell'installazione è costituita da un collegamento linea-neutro (come accade nella maggior parte delle installazioni europee), la tensione delle prese d'uscita è pari a 0 V. Con un cablaggio in entrata del tipo linea-linea, la tensione sulle prese d'uscita è 110–120 V (con misurazione effettuata da linea a terra o da linea a neutro in base al cablaggio dell'UPS).
- Non rimuovere nè scollegare il cavo di ingresso quando il gruppo statico di continuità è acceso poichè in tal modo si disattiverebbe il collegamento a terra di sicurezza del gruppo statico di continuità e dell'apparecchiatura ad esso collegata.
- Per ridurre il rischio di incendio o di scossa elettrica, installare il gruppo statico di continuità in un ambiente interno a temperatura ed umidità controllata, privo di agenti contaminanti conduttivi. La temperatura ambiente non deve superare i 40°C. Non utilizzare l'unità in prossimità di acqua o in presenza di umidità eccessiva (95% max).
- Per conformità con gli standard internazionali e con le norme in merito al cablaggio, tutta l'apparecchiatura collegata con l'uscita del gruppo statico di continuità non deve avere una corrente di dispersione di terra superiore a 1,5 milliampere.

ATTENZIONE



- Le batterie possono comportare un rischio di scossa elettrica o di ustione in seguito a un'elevata corrente di corto circuito. Osservare le dovute precauzioni. L'assistenza deve essere eseguita da personale qualificato esperto di batterie e delle necessarie precauzioni. Tenere il personale non autorizzato lontano dalle batterie.
- Le batterie devono essere smaltite in modo corretto. Per i requisiti di smaltimento fare riferimento alle disposizioni locali.
- Non gettare mai le batterie nel fuoco poichè potrebbero esplodere se esposte alle fiamme.

Viktig Sikkerhetsinformasjon

VIKTIGE SIKKERHETSINSTRUKSJONER GJEM DISSE INSTRUKSJONENE

Denne håndboken inneholder viktige instruksjoner som du bør overholde ved montering og vedlikehold av UPS-enheten og batteriene. Les alle instruksjoner før utstyret tas i bruk, og gjem håndboken til fremtidig referanse.



FARLIG

Denne UPS'en inneholder LIVSFARLIGE SPENNINGER. All reparasjon og service må kun utføres av AUTORISERT SERVICEPERSONALE. BRUKERE KAN IKKE UTFØRE SERVICE PÅ NOEN AV DELENE i UPS'en.



FARLIG

- UPS-enheten inneholder sin egen energikilde (batterier). Utgangsstikkene kan være strømførende selv når UPS-enheten ikke er koblet til et strømuttak.
- Utgangsstikkene kan være strømførende for 220–240V modellene. Spenningen til utgangsstikkene vil være 0 V dersom din enhets strømkilde er fase-til-nøytral (som på de fleste europeiske enheter). Med ledningsført fase-til-fase inngang vil spenningen til utgangsstikkene være 110–120V (målt fra fase-til-jord eller fase-til-nøytral, avhenging av UPS-ledningsføringen).
- Strømforsyningskabelen må ikke fjernes eller trekkes ut når UPS'en er på, slik at ikke sikkerhetsjordingen fjernes fra UPS'en og det utstyret som er forbundet med den.
- For å redusere fare for brann eller elektriske støt, bør denne UPS'en installeres i et innendørs miljø med kontrollert temperatur og luftfuktighet som er fritt for ledende, forurensende stoffer. Romtemperaturen må ikke overskride 40°C. Den må ikke brukes i nærheten av vann eller ved meget høy luftfuktighet (95% maks.).
- Alt utstyr som er forbundet med utgangen av denne UPS'en må ikke ha en sterkere total lekkasjestrøm enn 1,5 milliamperer for å være i overensstemmelse med internasjonale standarder og forkablingsbestemmelser.



FORSIKTIG

- Batterier kan utgjøre en fare for elektrisk støt eller brannskår pga. høy kortslutningsstrøm. Treff passende forholdsregler. Service bør utføres av kvalifisert servicepersonale med kjennskap til batterier og nødvendige forholdsregler. Hold uautorisert personale borte fra batteriene.
- Batterier må fjernes på korrekt måte. Se lokale forskrifter vedrørende krav om fjerning av batterier.
- Kast aldri batterier i flammer, da de kan eksplodere, hvis de utsettes for åpen ild.

Regulamentos de Segurança

INSTRUÇÕES DE SEGURANÇA IMPORTANTES GUARDE ESTAS INSTRUÇÕES

Este manual contém instruções importantes que devem ser seguidas durante a instalação e manutenção do no-break e das baterias. Leia todas as instruções antes de operar o equipamento e guarde este manual para consultá-lo futuramente.



CUIDADO

A UPS contém VOLTAGEM MORTAL. Todos os reparos e assistência técnica devem ser executados SOMENTE POR PESSOAL DA ASSISTÊNCIA TÉCNICA AUTORIZADO. Não há nenhuma PEÇA QUE POSSA SER REPARADA PELO USUÁRIO dentro da UPS.



ADVERTÊNCIA

- Este no-break possui sua própria fonte de energia (baterias). As tomadas de saída podem estar energizadas mesmo que o no-break não esteja conectado a uma fonte de energia elétrica.
- Nos modelos 220–240V, pode ser que as tomadas de saída permaneçam energizadas. Se a alimentação da sua aplicação for do tipo fase-neutro (como ocorre na maioria das aplicações na Europa), a tensão das tomadas de saída é de 0 V. Com a alimentação fase-fase, a tensão das tomadas de saída é de 110–120V (medida como fase-terra ou fase-neutro, dependendo da instalação elétrica do no-break).
- Não remova ou desconecte o cabo de entrada quando a UPS estiver ligada. Isto removerá o aterramento de segurança da UPS e do equipamento conectado.

- Para reduzir o risco de incêndios ou choques elétricos, instale a UPS em ambiente interno com temperatura e umidade controladas e livres de contaminadores condutíveis. A temperatura ambiente não deve exceder 40°C. Não opere próximo a água ou em umidade excessiva (máx: 95%).
- Para estar de acordo com os padrões internacionais e os regulamentos de fiação, o equipamento total conectado à saída desta UPS não deve ter uma corrente de fuga à terra maior que 1,5 miliampères.



PERIGO

- As baterias podem oferecer risco de choque elétrico ou queimadura, ocasionados por alta tensão com possibilidade de curto-circuito. Tome as precauções adequadas. A manutenção deve ser realizada por pessoal qualificado, com conhecimento sobre baterias e ciente das precauções exigidas. Mantenha o pessoal não autorizado afastado das baterias.
- Siga as instruções apropriadas ao desfazer-se das baterias. Consulte os códigos do local para maiores informações sobre os regulamentos de descarte de produtos.
- Nunca jogue as baterias no fogo, porque há risco de explosão.

Предупреждения по мерам безопасности

ВАЖНЫЕ УКАЗАНИЯ ПО МЕРАМ БЕЗОПАСНОСТИ СОХРАНИТЕ ЭТИ УКАЗАНИЯ

В данном руководстве содержатся важные инструкции по установке и обслуживанию источника бесперебойного питания (ИБП) и батарей. Перед работой с оборудованием прочтите все инструкции. Сохраните данное руководство для дальнейшего использования.



ОПАСНО

В данном ИБП имеются СМЕРТЕЛЬНО ОПАСНЫЕ НАПРЯЖЕНИЯ. Все работы по ремонту и обслуживанию должны выполняться ТОЛЬКО УПОЛНОМОЧЕННЫМ ОБСЛУЖИВАЮЩИМ ПЕРСОНАЛОМ. Внутри ИБП нет узлов, ОБСЛУЖИВАЕМЫХ ПОЛЬЗОВАТЕЛЕМ.



ПРЕДУПРЕЖДЕНИЕ

- В данном ИБП установлены собственные источники энергии (батареи). На выходных розетках может быть напряжение, даже если ИБП не подключен к сети переменного тока.
- На выходных розетках моделей с напряжением 220-240 В может быть напряжение. Если устройство рассчитано на тип подключения “фаза-нейтраль” (как большинство устройств, изготавливаемых в Европе), напряжение на выходных розетках равно 0 В. При типе подключения “фаза-фаза” напряжение на выходных розетках составляет 110-120 В (при измерении “фаза-земля” или “фаза-нейтраль”, в зависимости от электрической схемы ИБП).
- Не отсоединяйте сетевой шнур и не извлекайте его вилку из розетки при включенном ИБП. При этом защитное заземление отключается от ИБП и от оборудования, подключенного к ИПБ.
- Для снижения опасности пожара или поражения электрическим током устанавливайте ИБП в закрытом помещении с контролируемыми температурой и влажностью, в котором отсутствуют проводящие загрязняющие вещества. Температура окружающего воздуха не должна превышать 40°C. Не эксплуатируйте устройство около воды или в местах повышенной влажностью (макс. 95%).
- Для обеспечения соблюдения требований международных стандартов и требований к разводке электрических цепей, суммарная величина тока утечки на землю всего оборудования, подключенного к выходу ИБП, не должна превышать 1,5 миллиампера.



ОСТОРОЖНО

- Высокое напряжение, вызванное коротким замыканием в батарее, может привести к поражению электрическим током или ожогу. Соблюдайте меры предосторожности. Техническое обслуживание должно осуществляться квалифицированным персоналом по работе с источниками питания, знакомым с мерами предосторожности. Не допускайте к работе с батареями посторонних.
- Необходимо соблюдать правила утилизации аккумуляторов. Обратитесь к местным нормативным актам за информацией о требованиях к утилизации.
- Никогда не бросайте аккумуляторы в огонь. Аккумуляторы могут взорваться под воздействием огня.

Advertencias de Seguridad

INSTRUCCIONES DE SEGURIDAD IMPORTANTES GUARDE ESTAS INSTRUCCIONES

Este manual contiene instrucciones importantes que debe seguir durante la instalación y el mantenimiento del SIE y de las baterías. Por favor, lea todas las instrucciones antes de poner en funcionamiento el equipo y guarde este manual para referencia en el futuro.

PELIGRO



Este SIE contiene VOLTAJES MORTALES. Todas las reparaciones y el servicio técnico deben ser efectuados SOLAMENTE POR PERSONAL DE SERVICIO TÉCNICO AUTORIZADO. No hay NINGUNA PARTE QUE EL USUARIO PUEDA REPARAR dentro del SIE.

ADVERTENCIA



- Este SIE contiene su propia fuente de energía (baterías). Los receptáculos de salida pueden transportar voltaje activo aun cuando el SIE no esté conectado con una fuente de CA.
- Para los modelos 220–240V, es posible que los receptáculos de salida permanezcan eléctricamente activos. Si la fuente de energía de entrada de su aplicación está cableada de línea a neutro (como la mayoría de las aplicaciones europeas), el voltaje a los receptáculos de salida es 0V. Con cableado de entrada de línea a línea, el voltaje hacia los receptáculos de salida es 110–120V (medido de línea a tierra o de línea a neutro, lo que dependerá del cableado del SIE).
- No retire o desenchufe el cable de entrada mientras el SIE se encuentre encendido. Esto suprime la descarga a tierra de seguridad del SIE y de los equipos conectados al SIE.
- Para reducir el riesgo de incendio o de choque eléctrico, instale este SIE en un lugar cubierto, con temperatura y humedad controladas, libre de contaminantes conductores. La temperatura ambiente no debe exceder los 40°C. No trabaje cerca del agua o con humedad excesiva (95% máximo).
- Para cumplir con los estándares internacionales y las normas de instalación, la totalidad de los equipos conectados a la salida de este SIE no debe tener una intensidad de pérdida a tierra superior a los 1,5 miliamperios.



PRECAUCIÓN

- Las baterías pueden constituir un riesgo de descarga eléctrica o quemaduras por corriente alta de corto circuito. Adopte las precauciones debidas. Personal calificado de servicio que conozca de baterías y esté al tanto de las precauciones requeridas debe darle servicio al equipo. Mantenga al personal no autorizado alejado de las baterías.
- Es necesario desechar las baterías de un modo adecuado. Consulte las normas locales para conocer los requisitos pertinentes.
- Nunca deseche las baterías en el fuego. Las baterías pueden explotar si se las expone a la llama.

Säkerhetsföreskrifter

VIKTIGA SÄKERHETSFÖRESKRIFTER SPARA DESSA FÖRESKRIFTER

Den här anvisningen innehåller viktiga instruktioner som du ska följa under installation och underhåll av UPS-enheten och batterierna. Läs alla instruktioner innan du använder utrustningen och spara den här anvisningen för framtida referens.



FARA

Denna UPS-enhet innehåller LIVSFARLIG SPÄNNING. ENDAST AUKTORISERAD SERVICEPERSONAL får utföra reparationer eller service. Det finns inga delar som ANVÄNDAREN KAN UTFÖRA SERVICE PÅ inuti UPS-enheten.



VARNING

- Den här UPS-enheten innehåller sin egen energikälla (batterier). Uttagen kan vara spänningsförande även då UPS-enheten inte är ansluten till spänningsnätet.
- På modellerna 220 – 240 V kan de utgående uttagen fortfarande vara strömförande. Om den ingående strömkällan i din applikation är kopplad ledare-till-nolla (det vanligaste i Europa) är spänningen till de utgående uttagen 0 V. Är den ingående strömkällan kopplad ledare-till-ledare är spänningen i de utgående uttagen 110–120 V (uppmätt från ledare-till-jord eller ledare-till-nolla beroende på UPS:ens anslutning).
- Ta aldrig bort nätsladden när UPS-enheten är påslagen. Detta tar bort skyddsjordningen från både UPS-enheten och den anslutna utrustningen.

- Minska risken för brand eller elektriska stötar genom att installera denna UPS-enhet inomhus, där temperatur och luftfuktighet är kontrollerade och där inga ledande föroreningar förekommer. Omgivande temperatur får ej överstiga 40°C. Använd inte utrustningen nära vatten eller vid hög luftfuktighet (max 95 %).
 - För att överensstämna med internationell standard och installationsföreskrifter får inte den totala utrustning som anslutits till uttagen på denna UPS-enhet ha läcksström som överstiger 1,5 milliampere.
-



VIKTIGT

- Batterierna kan innebära en risk för elektrisk stöt eller brännskada från kortsluten starkström. Iakttag lämpliga försiktighetsåtgärder. Service ska utföras av utbildad servicepersonal med kunskap om batterierna och nödvändiga försiktighetsåtgärder. Håll ej behörig personal borta från batterierna.
 - Batterierna måste avyttras enligt anvisningarna i lokal lagstiftning.
 - Använda batterier får aldrig brännas upp. De kan explodera.
-

Chapter 3 Installation

This section explains:

- Equipment inspection
- UPS internal battery connection
- UPS setup and installation, including Extended Battery Modules (EBMs)
- Remote emergency power-off (REPO) installation
- UPS rear panels

Inspecting the Equipment

If any equipment has been damaged during shipment, keep the shipping cartons and packing materials for the carrier or place of purchase and file a claim for shipping damage. If you discover damage after acceptance, file a claim for concealed damage.

To file a claim for shipping damage or concealed damage: 1) File with the carrier within 15 days of receipt of the equipment; 2) Send a copy of the damage claim within 15 days to your service representative.



NOTE Check the battery recharge date on the shipping carton label. If the date has expired and the batteries were never recharged, do not use the UPS. Contact your service representative.

Connecting the UPS Internal Battery

To ensure proper battery operation:

1. Verify that the UPS is off and unplugged.
2. Remove the UPS front cover (see Figure 2).

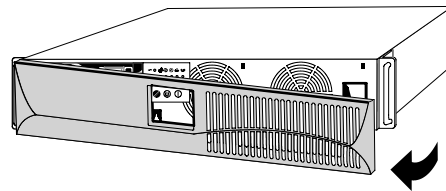

Figure 2. Removing the UPS Front Cover

3. Connect the internal battery connector (see Figure 3).

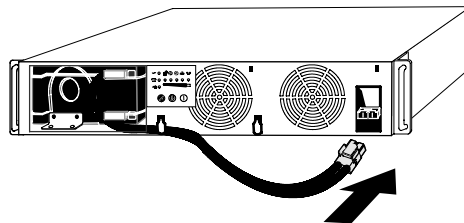

Figure 3. Connecting the Internal Battery Connector

4. Replace the UPS front cover (see Figure 4).

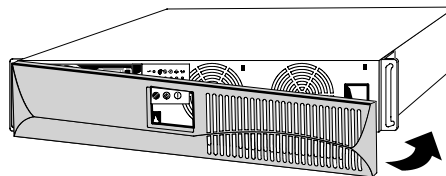

Figure 4. Replacing the UPS Front Cover

5. Continue to the following section, "UPS Setup."

UPS Setup

The Powerware 9125 UPS is designed for flexible configurations and can be installed in a rack or as a standalone cabinet.

If you are installing the UPS in a rack, continue to the following section “Rack-Mount Setup;” otherwise, continue to “Tower Setup” on page 22.

Rack-Mount Setup

The UPS can be installed in 19- or 23-inch racks and needs only 2U of valuable rack space.

CAUTION



The UPS and EBM are heavy (see page 53). A minimum of two people are required to lift the cabinets into the rack.



NOTE Mounting rails are required for each UPS and EBM cabinet. If rails are not already installed in your rack, contact your local distributor to order rail kits.

To install the UPS and optional EBMs in a rack:

1. Place the UPS on a flat, stable surface with the front of the UPS facing toward you.
2. Attach the supplied mounting handles to the mounting brackets and secure with the supplied screws (see Figure 5).
3. Align the mounting brackets with the screw holes on the sides of the UPS and secure with the supplied screws (see Figure 5).
4. If installing optional EBMs, repeat Steps 1 through 3 for each cabinet.

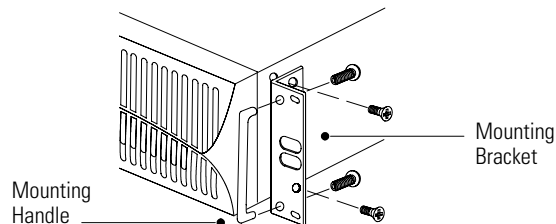

Figure 5. Installing the Mounting Handles and Brackets



NOTE The EBMs must be installed below the UPS as shown in Figure 6.

5. Slide the UPS and any optional EBMs into the rack.
6. Secure the cabinets to the rack according to the rail kit instructions.
7. Continue to “Installing the UPS” on page 25 to complete the installation.

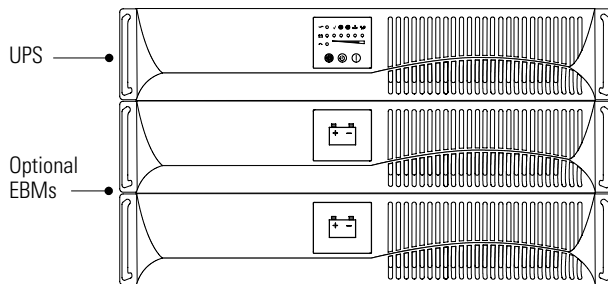

Figure 6. Rack-Mount UPS with EBMs

Tower Setup

The tower setup varies depending on the number of cabinets you are installing:

1. **For one cabinet**, the pedestals must be installed. Continue to Step 2.
For two or more cabinets, the joining brackets must be installed. Skip to Step 6.
2. Place the UPS cabinet horizontally so that the left end of the cabinet is accessible (see Figure 7).
3. Slide and align the UPS pedestals with the screw holes on the end of the UPS cabinet. Secure the pedestals with the screws provided in the accessory kit.

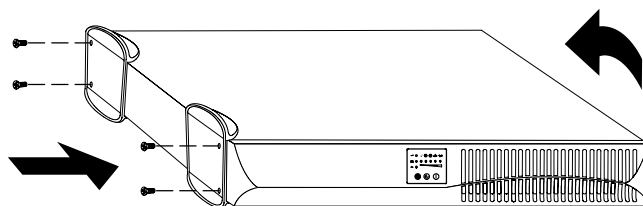

Figure 7. Installing the UPS Pedestals

- 4. Carefully position the cabinet upright with the air vents at the top (see Figure 8).
- 5. Continue to "Installing the UPS" on page 25 to complete the installation.

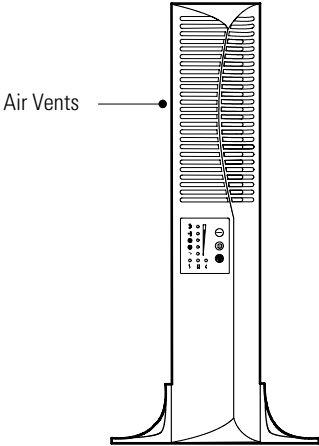

Figure 8. UPS with Pedestals

- 6. Carefully position the cabinets upright with the air vents at the top (see Figure 9).

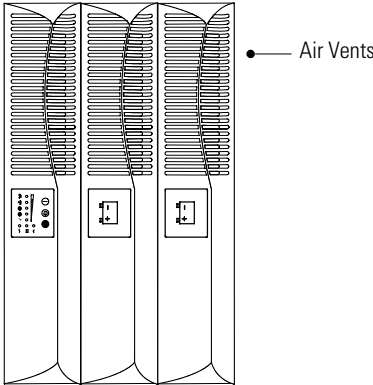

Figure 9. Tower UPS with EBMs

7. Remove the adjacent corner screws from the rear panels as shown in Figure 10 to install the joining brackets. Discard the screws.
8. Align each joining bracket with the screw holes and secure with the screws provided in the accessory kit.
9. If installing additional EBMs, repeat Steps 7 and 8 for each cabinet.
10. Continue to the following section, "Installing the UPS," to complete the installation.

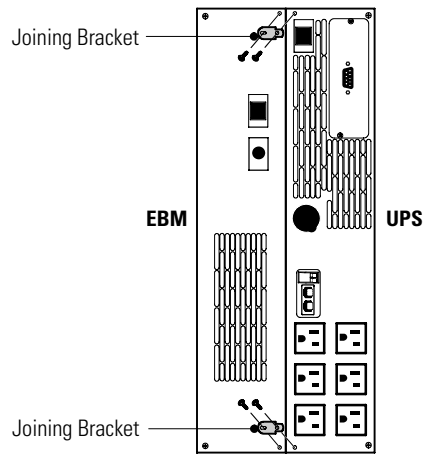

Figure 10. Installing the Joining Brackets

Installing the UPS



NOTE Do not make unauthorized changes to the UPS or accessories; otherwise, damage may occur to your equipment and void your warranty.

Figure 11 shows a typical installation only. See “UPS Rear Panels” on page 29 for the rear panel of each model.

To install the UPS and optional EBMs:

1. If installing an optional EBM, continue to Step 2; otherwise, skip to Step 3.
2. Plug the EBM cable(s) into the battery connector(s) as shown in Figure 11. Up to four EBMs may be connected to the UPS.

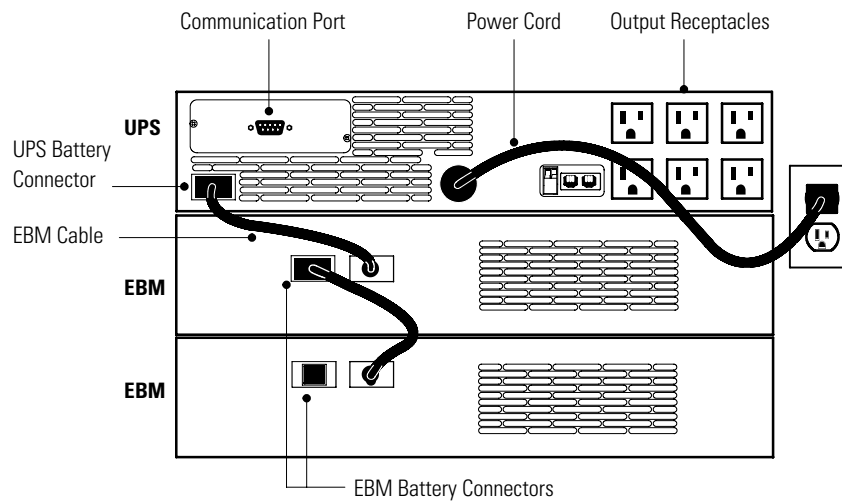



Figure 11. Typical UPS Installation with Two EBMs

3. If you are installing power management software, connect your computer to the UPS communication port using the supplied communication cable.
4. Plug the equipment to be protected into the appropriate UPS output receptacles (see page 46 for more information on load segments).



NOTE DO NOT protect laser printers with the UPS because of the exceptionally high power requirements of the heating elements.

5. If an emergency power-off (disconnect) switch is required by local codes, see the following section, "Remote Emergency Power-off Installation," to install the REPO switch before powering on the UPS.
6. **For 230V models only.** Plug the detachable UPS power cord into the input connector on the UPS rear panel.
7. Plug the UPS power cord into a power outlet.

All front panel indicators flash briefly and the UPS conducts a self-test. When the self-test is complete, the ~ indicator flashes, indicating the UPS is in Standby mode with the equipment offline. If the  or  indicator flashes, see page 59.

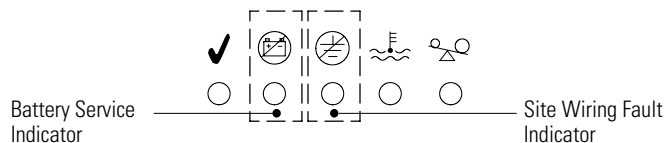

Figure 12. Fault Indicators

8. Press the On | button.

The ~ indicator illuminates solid and the bar graph indicators display the percentage of load being applied to the UPS. The UPS is now in Normal mode and supplying power to your equipment.

To change the factory-set defaults, see "Configuration" on page 37.



NOTE The batteries charge to 80% capacity in approximately 2 hours. However, it is recommended that the batteries charge for 36 hours after installation or long-term storage.



NOTE If you installed power management software and optional EBMs, ensure maximum battery runtime by using the ERM configurator tool on the Software Suite CD and connecting a minimum load of 10% (15% recommended) to the UPS.

Remote Emergency Power-off Installation

The Powerware 9125 includes a REPO port that allows power to be switched off at the UPS output receptacles from a customer-supplied switch in a remote location.

The REPO feature shuts down the protected equipment immediately and does not follow the orderly shutdown procedure initiated by any power management software.

Any devices that are operating on battery power are also shut down immediately. When the REPO switch is reset, the equipment will not return to battery power until the UPS is manually restarted.

If the Off  button is pressed after the REPO is activated, the UPS remains in Standby mode when restarted until the On  button is pressed.

WARNING



The REPO circuit is an IEC 60950 safety extra low voltage (SELV) circuit. This circuit must be separated from any hazardous voltage circuits by reinforced insulation.

CAUTION



To ensure the UPS stops supplying power to the load during any mode of operation, the input power must be disconnected from the UPS when the emergency power-off function is activated.



NOTE The REPO function activates when the REPO contacts close.

NOTE For Europe, the emergency switch requirements are detailed in Harmonized document HD-384-48 S1, "Electrical Installation of the Buildings, Part 4: Protection for Safety, Chapter 46: Isolation and Switching."

To install the REPO switch:

1. Verify that the UPS is off and unplugged.
2. Remove the REPO connector from the accessory kit.
3. Connect isolated, normally-open, dry contacts (rated to handle 60 Vdc maximum, 30 Vac RMS maximum, and 20 mA maximum) across the REPO device to Pin 1 and Pin 2 (see Figure 13). Use stranded, non-shielded wiring, size 0.75 mm²–0.5 mm² (18–20 AWG).



NOTE *A separate contact must simultaneously cause UPS input AC power to be removed.*

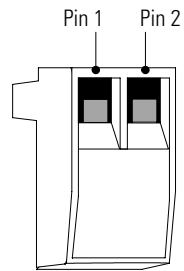

Figure 13. REPO Connector

4. Connect the REPO connector to the REPO port on the UPS rear panel.
5. Verify that the externally-connected REPO switch is not activated to enable power to the UPS output receptacles.
6. Plug in the UPS and start the UPS by pressing the On | button.
7. Activate the external REPO switch to test the REPO function.
8. De-activate the external REPO switch and restart the UPS.

UPS Rear Panels

This section shows the rear panels of the Powerware 9125 models.

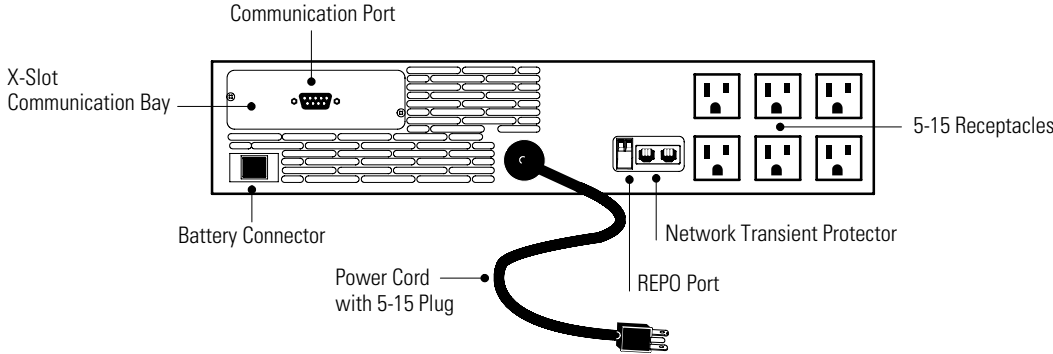

Figure 14. 700–1500 VA, 120V Rear Panel

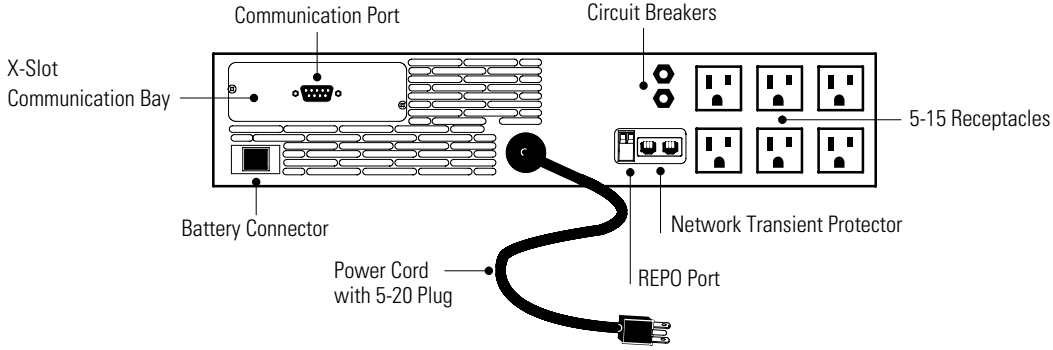

Figure 15. 2000 VA, 120V Rear Panel (with 5-15R)

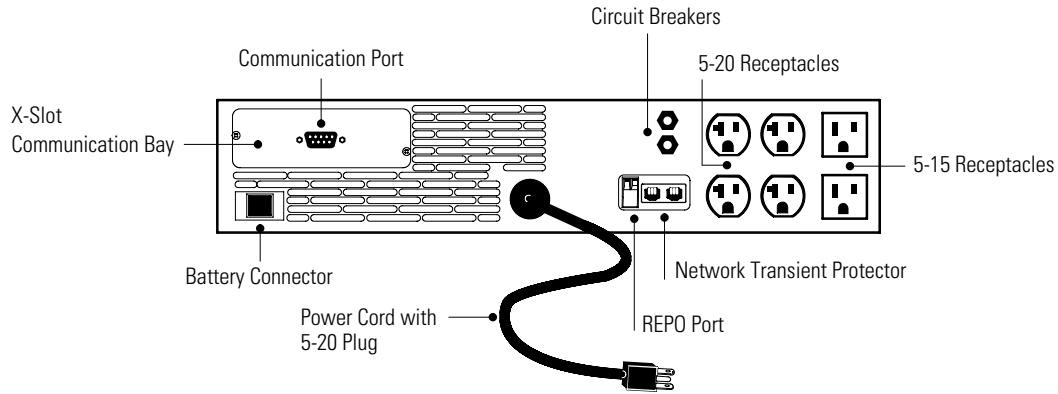

Figure 16. 2000 VA, 120V Rear Panel (with 5-20R)

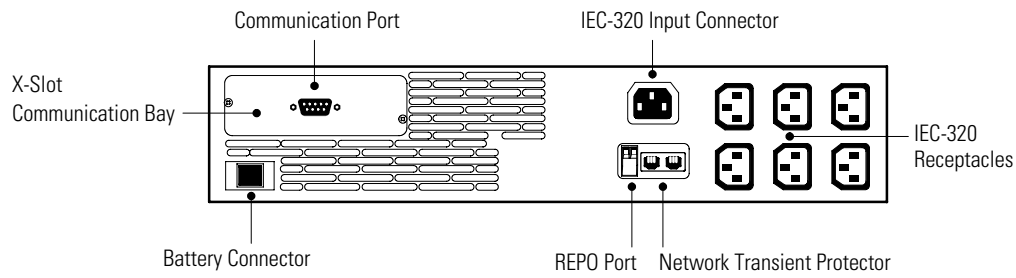

Figure 17. 700-2000 VA, 230V Rear Panel

Chapter 4 Operation

This section describes:

- Turning the UPS on and off
- Starting the UPS on battery
- Initiating the self-test
- Operating modes

Turning the UPS On

After the UPS is connected to a power outlet, it conducts a self-test and enters Standby mode.

To turn on the UPS, press the On | button on the front panel. The  indicator illuminates solid and the bar graph indicators display the percentage of load being applied to the UPS.

Starting the UPS on Battery

To turn on the UPS without using utility power, press and hold the On | button for at least four seconds. The UPS starts up in Battery mode and supplies battery power to your equipment. When the UPS starts on battery, it does not conduct a self-test to conserve battery power.

Turning the UPS Off



NOTE Pressing the Off  button while the UPS is in Battery mode causes the UPS to shut down immediately.

To turn off the UPS:

1. Prepare your equipment for shutdown.
2. Press and hold the Off  button for approximately three seconds. The UPS transfers to Standby mode (if utility power is available) and removes power from your equipment.
3. Unplug the UPS; the UPS shuts down in five seconds. All front panel indicators flash briefly twice prior to shutdown.

If you do not unplug the UPS, it remains in Standby mode.

Initiating the Self-Test



NOTE The batteries must be fully charged and the UPS must not be in Battery mode to perform the self-test.

NOTE Load must be applied to the UPS to perform the battery test. Apply the following load amounts according to the UPS rating: 50% load for 700 VA; 35% load for 1000 VA; 45% load for 1250 VA; 38% load for 1500 VA; or 25% load for 2000 VA.

Press and hold the  button for three seconds to initiate the self-test. During the five-second test, the bar graph indicators cycle through twice. If the alarm beeps or a UPS alarm indicator stays on, see Table 10 on page 58.

Operating Modes

The Powerware 9125 front panel indicates the UPS status through the UPS indicators. Figure 18 shows the UPS front panel indicators and controls.

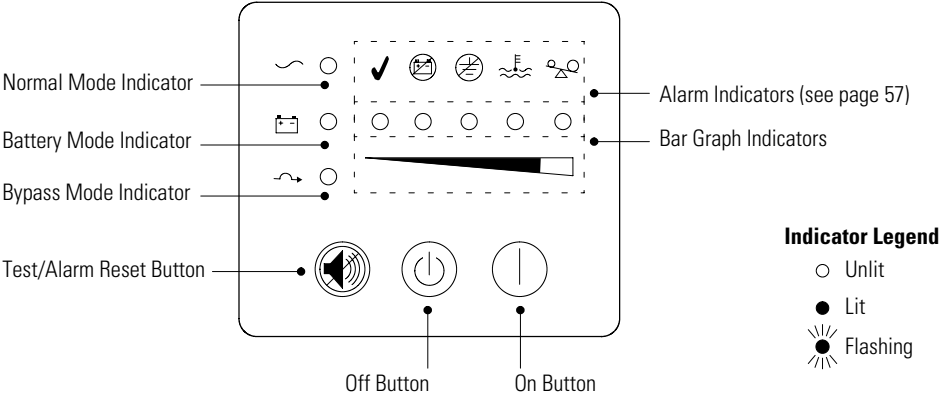

Figure 18. UPS Front Panel

Normal Mode

During Normal mode, the \sim indicator illuminates and the front panel displays the percentage of UPS load capacity being used by the protected equipment (see Figure 19). The UPS monitors and charges the batteries as needed and provides power protection to your equipment.

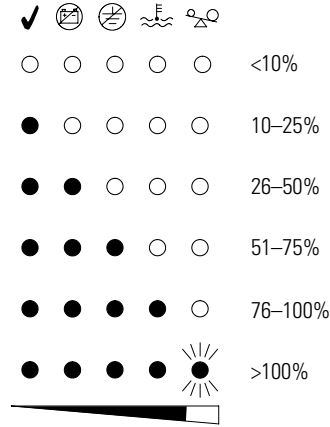



Figure 19. Load Level Indicators

When all of the bar graph indicators are illuminated and the \sim indicator flashes, power requirements exceed UPS capacity; see page 59 for more information.

Battery Mode

When the UPS is operating during a power outage, the alarm beeps once per second and the  indicator illuminates. The front panel displays the approximate percentage of battery capacity remaining (see Figure 20).

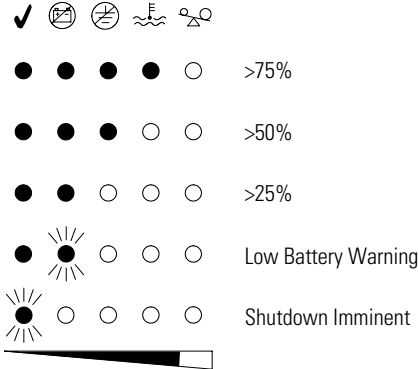



Figure 20. Battery Capacity Indicators

If battery capacity becomes low while in Battery mode, the  indicator starts flashing and the alarm becomes continuous. This warning is approximate, and the actual time to the Shutdown Imminent warning may vary significantly.



NOTE Depending on the UPS load and number of Extended Battery Modules (EBMs), the Low Battery warning may occur before the batteries reach 25% capacity. See Table 9 on page 56 for estimated runtimes.

When shutdown is imminent, the  indicator flashes. Immediately complete and save your work to prevent data loss and similar difficulties.

If utility power returns before UPS shutdown, the UPS transfers to Normal mode operation while the battery recharges.

If utility power returns after UPS shutdown, the UPS automatically restarts.

Bypass Mode

In the event of a UPS overload or internal failure, the UPS transfers your equipment to utility power. Battery mode is not available; however, the utility power continues to be passively filtered by the UPS. The  indicator illuminates. The UPS transfers to Bypass mode when:

- The UPS has an overtemperature condition.
- The UPS has an overload condition of 101 to 110% for 2 minutes.
- The UPS has an overload condition of 111 to 150% for 30 seconds.
- The UPS detects a fault in the battery or UPS electronics.

Standby Mode

When the UPS is turned off and remains plugged into a power outlet, the UPS is in Standby mode. The  indicator flashes and the bar graph indicators are off, indicating that power is not available to your equipment. The battery recharges when necessary.



NOTE For 220–240V models, the output receptacles may remain electrically live (up to 110–120V). Unplug the UPS to ensure power is not available to the output receptacles.

Chapter 5 Configuration



When the UPS is in Configuration mode, the bar graph indicators represent the configuration options. Use the control buttons (On | button and  button) to modify the UPS configuration. Figure 21 shows the LEDs and Table 1 explains the corresponding options.



NOTE *The UPS can be configured while in Battery mode. If the UPS transfers to battery power while in Configuration mode, the UPS remains in Configuration mode and indicates Battery mode on the front panel after exiting Configuration mode.*



CAUTION

DO NOT press the Off  button while the UPS is in Configuration mode; pressing the Off  button removes all power to your equipment immediately and the UPS enters Standby mode.

To reconfigure the UPS default settings:

1. Press and hold the On | button and the  button simultaneously for approximately three seconds. The UPS transfers to Configuration mode.

The LEDs flash briefly and then display the enabled options.

2. Press the On | button to scroll through the options. Each time you press the button, the UPS beeps. The LED for the selected option indicates the current setting; flashing represents disabled options (see Figure 21 and Table 1).

Scrolling past the last LED returns to the first configuration option.

If you press the On | button and nothing happens, the UPS is still in Operation mode. Repeat Step 1 to enter Configuration mode, and then perform Step 2.

3. Press the  button ONCE to select the Voltage option or to toggle the Site Wiring Fault Alarm or AC Input Failure Alarm on or off.



NOTE *The UPS automatically exits Configuration mode after two minutes.*

4. Press and hold the On | button and the  button simultaneously for three seconds to exit Configuration mode at any time.

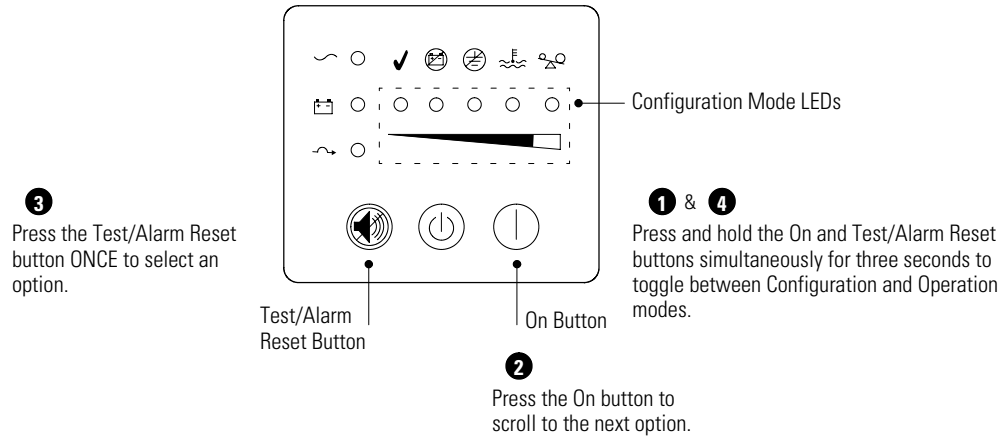
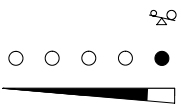
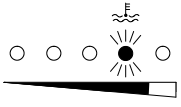
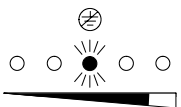
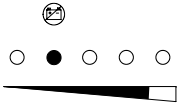
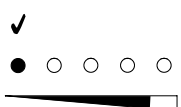

Figure 21. Using Configuration Mode

Table 1. Configuration Mode LEDs and Options

Configuration Mode LEDs	Option	LED Status	Explanation
	120/230V Nominal Input Voltage	On (default)	Nominal input voltage is 120V for low voltage models and 230V for high voltage models. All other nominal input voltages are disabled.
		Flashing	120/230V is disabled; one of the other input voltage options is selected.
	110/220V Nominal Input Voltage	On	Nominal input voltage is 110V for low voltage models 220V for high voltage models. All other nominal input voltages are disabled.
		Flashing (default)	110/220V is disabled; one of the other input voltage options is selected.
	127/240V Nominal Input Voltage	On	Nominal input voltage is 127V for low voltage models and 240V for high voltage models. All other nominal input voltages are disabled.
		Flashing (default)	127/240V is disabled; one of the other input voltage options is selected.
	Site Wiring Fault Alarm	On (default)	Alarm sounds when the polarity of the outlet is reversed or the ground connection is missing; have a qualified electrician repair the outlet wiring.
		Flashing*	Alarm DOES NOT sound when the polarity of the outlet is reversed or the ground connection is missing. * For 230V models, Site Wiring Fault is not available (flashing is the only status).
	AC Input Failure	On (default)	Alarm sounds when there is an AC input failure.
		Flashing	Alarm DOES NOT sound when there is an AC input failure.

NOTE 208V nominal input voltage is available. Contact the Help Desk at one of the telephone numbers on page 60 for assistance.

Chapter 6 Additional UPS Features

This section describes:

- X-Slot cards
- Network transient protector
- Load segments

X-Slot Cards

X-Slot cards allow the UPS to communicate in a variety of networking environments and with different types of devices. The Powerware 9125 is factory-installed with a Single-Port Card or USB Card, depending on the customer order.

- ConnectUPS™-X Web/SNMP Card - has SNMP and HTTP capabilities as well as monitoring through a Web browser interface; connects to a twisted-pair Ethernet (10/100BaseT) network. It has a built-in switching hub that allows three additional network devices to be connected to the network without the requirement of additional network drops. In addition, a Powerware Environmental Monitoring Probe can be attached to obtain humidity, temperature, smoke alarm, and security information.
- Relay Interface Card - has isolated dry contact (Form-C) relay outputs for UPS status: Utility failure, Low battery, UPS alarm/OK, or On bypass.
- Modbus® Card - allows you to continuously and reliably monitor the UPSs in your Building Management System (BMS).
- Multi-Server Card - has six serial communication ports that can communicate simultaneously with other computers using Powerware LanSafe® Power Management Software (provided on the Software Suite CD).
- Single-Port Card - connects to the Powerware Expansion Chassis to enable multiple communication options or to a PC for power management control.
- USB Card - connects to a USB port on your computer.

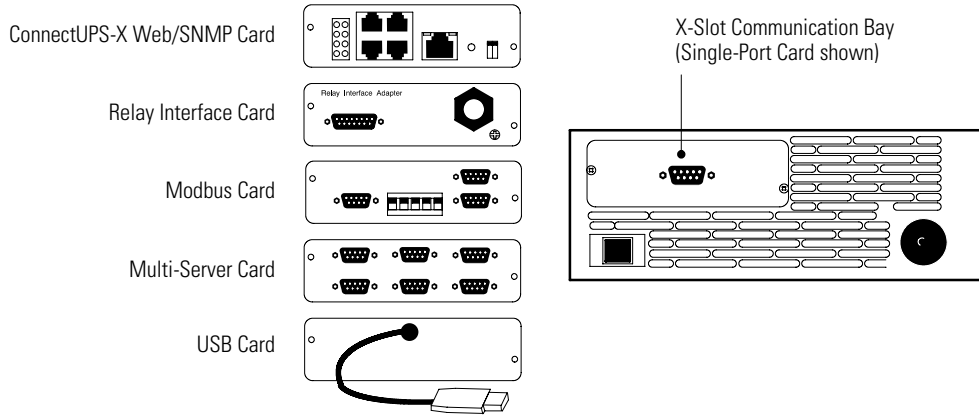

Figure 22. Optional X-Slot Cards

Single-Port Card

To establish communication between the UPS and a computer, connect your computer to the UPS communication port using the supplied communication cable.

When the communication cable is installed, power management software can exchange data with the UPS. The software polls the UPS for detailed information on the status of the power environment. If a power emergency occurs, the software initiates the saving of all data and an orderly shutdown of the equipment.

The cable pins are identified in Figure 23 and the pin functions are described in Table 2.

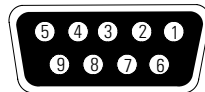

Figure 23. Communication Port

Table 2. Communication Port Pin Assignment

Pin Number	Signal Name	Function	Direction from the UPS
1	Low Batt	Low Battery relay contact; 20 mA, 30 Vdc contact rating	Out
2	TxD	Transmit to external device	Out
3	RxD	Receive from external device	In
4	DTR	PnP (Plug and Play) from external device (tied to Pin 6)	In
5	GND	Signal common (tied to chassis)	—
6	DSR	To external device (tied to Pin 4)	Out
7	RTS	PnP from external device (default) or On Bypass relay contact (jumper-selectable)	In / Out
8	AC Fail	AC Fail relay contact; 20 mA, 30 Vdc contact rating	Out
9	Power Source	+V (8 to 24 volts DC power)	Out

The On-Bypass Relay Contact. You can enable the On-Bypass relay using the jumper on the Single-Port Card. The jumper default is disabled.

To enable the On-Bypass relay:

1. Remove the Single-Port Card on the UPS rear panel. Retain the screws (see Figure 24).

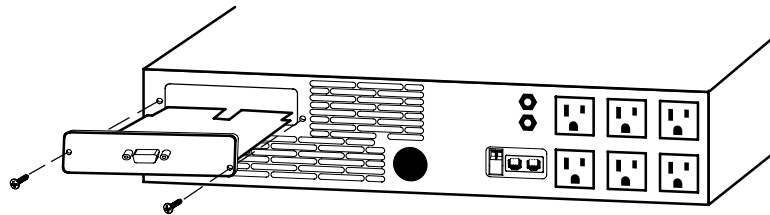

Figure 24. Removing the Single-Port Card

2. Move the J3 jumper to the AS/400® position to enable the On-Bypass relay as shown in Figure 25.

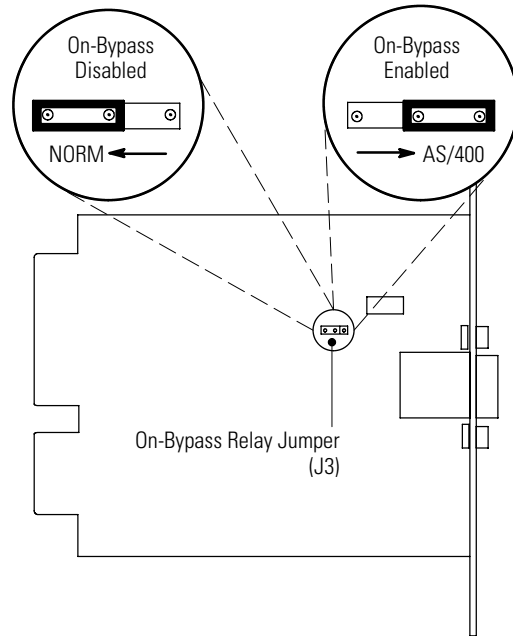

Figure 25. On-Bypass Relay Jumper

3. To prevent electrostatic discharge (ESD), place one hand on a metal surface such as the UPS rear panel.

Align the Single-Port Card with the slot guides and slide the card into the slot until it is firmly seated.

4. Secure the Single-Port Card with the screws removed in Step 1.

USB Card

With this card, the UPS can communicate with a USB-compliant computer using Powerware LanSafe Power Management Software (v5.0.1 or higher).

To establish communication between the UPS and a computer:

1. Connect the USB cable to the USB port on your computer.
2. Install the Powerware LanSafe software and USB drivers according to the instructions provided with the Software Suite CD.

Network Transient Protector

The network transient protector, shown in Figure 26, is located on the rear panel and has jacks labeled IN and OUT. This feature accommodates a single RJ-45 (10BaseT) network connector.

Low voltage models can also accommodate an RJ-11 telephone connector that provides protection for modems, fax machines, or other telecommunications equipment. As with most modem equipment, it is not advisable to use this jack in digital PBX (Private Branch Exchange) environments.



NOTE *DO NOT connect any telephone or fax/modem equipment to the 230V models; only network protection is available for 230V models.*

1. Connect the network or telephone (low voltage models only) cable to the jack labeled IN.
2. Connect the input connector of the equipment you are protecting to the jack labeled OUT.

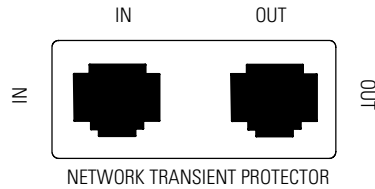

Figure 26. Network Transient Protector

Load Segments

Load segments are sets of receptacles that can be controlled by power management software, providing an orderly shutdown and startup of your equipment. For example, during a power outage, you can keep key pieces of equipment running while you turn off other equipment. This feature allows you to save battery power. See your power management software manual for details (refer to the Software Suite CD or www.powerware.com for the latest information).



NOTE *If power management software is not used, the individual load segments cannot be controlled.*

Each UPS has two load segments as shown in Figure 27 and Figure 28. Figure 27 shows the load segments for all models except the PW9125 2000 20R model (shown in Figure 28).

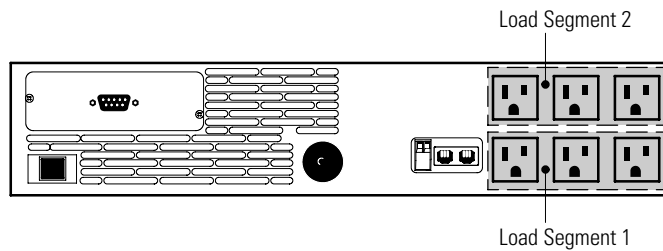

Figure 27. UPS Load Segments (120V Model Shown)

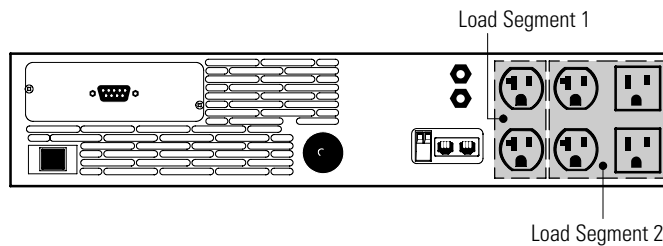

Figure 28. UPS Load Segments for PW9125 2000 20R

Chapter 7 UPS Maintenance

This section explains how to:

- Care for the UPS and batteries
- Replace the batteries
- Test new batteries
- Recycle used batteries or UPS

UPS and Battery Care

For the best preventive maintenance, keep the area around the UPS clean and dust-free. If the atmosphere is very dusty, clean the outside of the system with a vacuum cleaner.

For full battery life, keep the UPS at an ambient temperature of 25°C (77°F).



NOTE *If the UPS requires any type of transportation, verify that the UPS is unplugged and turned off and then disconnect the UPS internal battery connector using the steps in “Connecting the UPS Internal Battery” on page 20 in reverse order.*





NOTE *The batteries in the UPS are rated for a 3–5 year service life. The length of service life varies, depending on the frequency of usage and ambient temperature. Batteries used beyond expected service life will often have severely reduced runtimes. Replace batteries at least every 5 years to keep units running at peak efficiency.*

Storing the UPS and Batteries

If you store the UPS for a long period, recharge the battery every 12 months by plugging the UPS into a power outlet. The batteries charge to 80% capacity in approximately 2 hours. However, it is recommended that the batteries charge for 36 hours after long-term storage.

Check the battery recharge date on the shipping carton label. If the date has expired and the batteries were never recharged, do not use the UPS. Contact your service representative.

When to Replace Batteries

When the  indicator flashes, the batteries may need replacing. Conduct a self-test by pressing and holding the  button for three seconds. After the test is complete, the  indicator should turn off (it may take a few seconds to turn off). If the  indicator continues to flash, contact your service representative to order new batteries.

Replacing Batteries



NOTE *DO NOT DISCONNECT the batteries while the UPS is in Battery mode.*

With the hot-swappable battery feature, UPS batteries can be replaced easily without turning the UPS off or disconnecting the load.

If you prefer to remove input power to change the batteries, see “Turning the UPS Off” on page 32.

Consider all warnings, cautions, and notes before replacing batteries.

WARNING



- Batteries can present a risk of electrical shock or burn from high short-circuit current. The following precautions should be observed: 1) Remove watches, rings, or other metal objects; 2) Use tools with insulated handles; 3) Do not lay tools or metal parts on top of batteries.
 - **ELECTRIC ENERGY HAZARD.** Do not attempt to alter any battery wiring or connectors. Attempting to alter wiring can cause injury.
-

How to Replace Internal Batteries

CAUTION



Pull the battery out onto a flat, stable surface. The battery is unsupported when you pull it out of the UPS.

To replace the UPS internal batteries:

1. Remove the UPS front cover (see Figure 29).



NOTE *DO NOT* attempt to open the left side.

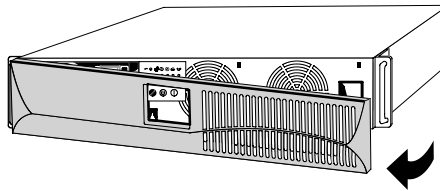

Figure 29. Removing the UPS Front Cover

2. Unscrew and set aside the battery retaining bracket (see Figure 30).
3. Disconnect the battery cable from the UPS battery connector and remove the battery cable from the wire clips.

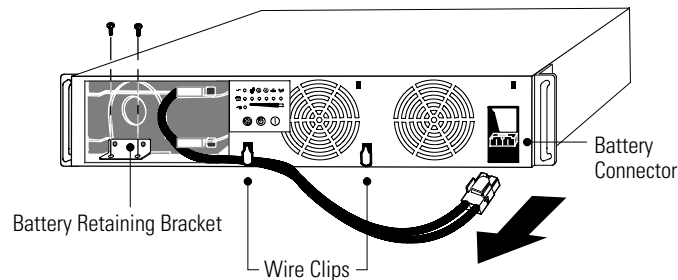

Figure 30. Accessing the UPS Internal Battery

4. Pull the battery out onto a flat, stable surface (see Figure 31). See “Recycling the Used Battery or UPS” on page 52 for proper disposal.

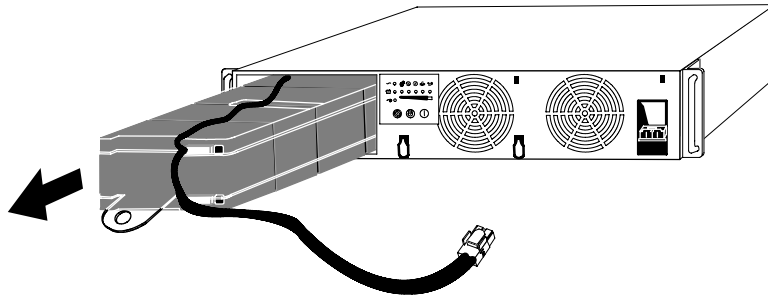

Figure 31. Removing the Battery

5. Slide the new battery into the UPS.
6. Reconnect the battery cable and secure the battery cable in the wire clips.
7. Reinstall the battery retaining bracket and screws removed in Step 2.
8. Replace the UPS front cover.

How to Replace Extended Battery Modules

CAUTION



The Extended Battery Module (EBM) is heavy (see page 53). A minimum of two people are required to lift the cabinets into the rack.

To replace the EBMs:

1. Unplug the EBM cable from the UPS.
If additional EBMs are installed, unplug the EBM cable from the battery connector on each EBM.
2. If the EBM is in a tower configuration, remove the joining brackets.
3. If the EBM is in a rack, install the supplied mounting handles and brackets on the new EBM.

4. Replace the EBM. See “Recycling the Used Battery or UPS” on page 52 for proper disposal.
5. Reinstall the joining brackets if removed in Step 2.
6. Plug the new EBM into the UPS as shown in Figure 32.

For additional EBMs, plug the EBM cable into the battery connector on the adjacent EBM.

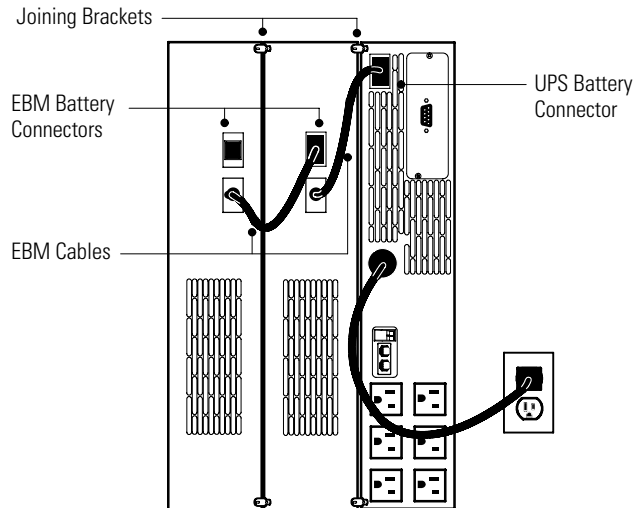

Figure 32. EBM Connections (120V Model Shown)





NOTE The battery connectors are designed to ensure proper connection with the correct EBM model (use EBM model PW9125 24 EBM with 700–1000 VA UPSs and EBM model PW9125 48 EBM with 1250–2000 VA UPSs).

Testing New Batteries



NOTE The batteries must be fully charged and the UPS must not be in Battery mode to perform the self-test.

NOTE For an accurate battery test, apply the following load amounts to the UPS: 50% load for 700 VA; 35% load for 1000 VA; 45% load for 1250 VA; 38% load for 1500 VA; or 25% load for 2000 VA.

Press and hold the  button for three seconds to initiate a self-test. After the test is complete, the  indicator should turn off (it may take a few seconds to turn off). If the  indicator continues to flash, check the battery connections. Call your service representative if the problem persists.

Recycling the Used Battery or UPS

Contact your local recycling or hazardous waste center for information on proper disposal of the used battery or UPS.

WARNING



- Do not dispose of the battery or batteries in a fire. Batteries may explode. Proper disposal of batteries is required. Refer to your local codes for disposal requirements.
- Do not open or mutilate the battery or batteries. Released electrolyte is harmful to the skin and eyes. It may be toxic.

CAUTION



Do not discard the UPS or the UPS batteries in the trash. This product contains sealed, lead-acid batteries and must be disposed of properly. For more information, contact your local recycling/reuse or hazardous waste center.

CAUTION



Do not discard waste electrical or electronic equipment (WEEE) in the trash. For proper disposal, contact your local recycling/reuse or hazardous waste center.

Chapter 8 Specifications

This section provides the following specifications:

- Model list
- Weights and dimensions
- Electrical input and output
- Environmental and safety
- Battery

Table 3. Model List

	120V Models	230V Models
UPS Models	PW9125 700 PW9125 1000 PW9125 1250 PW9125 1500 PW9125 2000 PW9125 2000 20R	PW9125 700i PW9125 1000i PW9125 1250i PW9125 1500i PW9125 2000i

NOTE The model numbers shown are for gray units; model numbers for black units end with “BLK.”

Table 4. Weights and Dimensions

	UPS	Extended Battery Module (EBM)
Dimensions (WxDxH)	43.2 x 49.3 x 8.9 cm 17.0" x 19.4" x 3.5" (2U)	43.2 x 49.3 x 8.9 cm 17.0" x 19.4" x 3.5" (2U)
Weights	700–1000 VA: 15 kg (34 lb) 1250–2000 VA: 23 kg (50 lb)	29.5 kg (65 lb)

Table 5. Electrical Input

	120V Models	230V Models
Nominal Voltage	120V default; 110, 120, 127V selectable*	230V default; 220, 230, 240V selectable*
Voltage Range	80–144V for 110, 120, 127V nominal	160–288V for 220, 230, 240V nominal
Nominal Frequency	45–65 Hz, 50/60 Hz auto-sensing	
Noise Filtering	MOVs and line filter for normal and common mode noise	
Connections	700–1500 VA: 6-ft, 5-15P power cord 2000 VA: 6-ft, 5-20P power cord	10A, IEC 320-C14 input connector

* 208V nominal input voltage is available. Contact the Help Desk at one of the telephone numbers on page 60 for assistance.

Table 6. Electrical Output

	120V Models	230V Models
Power Levels (Rated at Nominal Inputs)	PW9125 700: 700 VA, 490W PW9125 1000: 1000 VA, 700W PW9125 1250: 1250 VA, 875W PW9125 1500: 1500 VA, 1050W PW9125 2000: 2000 VA, 1400W PW9125 2000 20R: 2000 VA, 1400W	PW9125 700i: 700 VA, 490W PW9125 1000i: 1000 VA, 700W PW9125 1250i: 1250 VA, 875W PW9125 1500i: 1500 VA, 1050W PW9125 2000i: 2000 VA, 1400W
Regulation (Normal Mode)	Nominal output voltage $\pm 3\%$	
Regulation (Battery Mode)	Nominal output voltage $\pm 3\%$	
Voltage Waveform	Normal mode: Sine wave; <5% THD with full PFC and nonlinear load	
Output Receptacles	(6) 5-15R PW9125 2000 20R only: (4) 5-20R, (2) 5-15R	(6) IEC-320

Table 7. Environmental and Safety

	120V Models	230V Models
Operating Temperature	0°C to 40°C (32°F to 104°F) Optimal battery performance: 25°C (77°F)	
Storage Temperature	0°C to 25°C (32°F to 77°F)	
Transit Temperature	-25°C to 55°C (-13°F to 131°F)	
Relative Humidity	5–90% noncondensing	
Operating Altitude	Up to 3,000 meters above sea level	
Transit Altitude	Up to 10,000 meters above sea level	
Heat Dissipation (Recharge Mode up to 8 Hours)	700 VA: 472 BTU/hr 1000 VA: 601 BTU/hr 1250 VA: 879 BTU/hr 1500 VA: 986 BTU/hr 2000 VA: 1201 BTU/hr	
Audible Noise	Less than 45 dBA Normal mode, typical load Less than 50 dBA Battery mode	
Surge Suppression	ANSI C62.41 Category B (formerly IEEE 587)	
Safety Conformance	UL 1778, UL 497A; CSA C22.2, No. 107.1, 107.2; NOM-019-SCFI	UL 1778, UL 497A; CSA C22.2, No. 107.1, 107.2; EN 62040-1-1 and IEC 60950-1; NOM-019-SCFI
Agency Markings	cULus, CSA, NOM	cULus, CSA, CE, NOM, NEMKO
EMC (Class B)	FCC Part 15, ICES-003, VCCI	EN 50091-2, FCC Part 15, ICES-003, VCCI

Table 8. Battery

UPS Configuration	700–1000 VA: (2) 12V, 9 Ah internal batteries 1250–2000 VA: (4) 12V, 9 Ah internal batteries
EBM Configuration	PW9125 24 EBM: (8) 12V, 9 Ah PW9125 48 EBM: (8) 12V, 9 Ah
Type	Sealed, maintenance-free, valve-regulated, lead-acid
Charging	Internal battery: approximately 2 hours to 80% usable capacity at nominal line voltage after full load discharge External battery: no more than 10x discharge time to 90% usable capacity at nominal line voltage after full load discharge
Monitoring	Advanced monitoring for earlier failure detection and warning

Table 9. Battery Runtimes (in Minutes)

700–1000 VA Models					
Load	UPS Internal Batteries	+1 EBM	+2 EBMs	+3 EBMs	+4 EBMs
200 VA/140W	37	271	546		
400 VA/280W	19	142	278		
700 VA/490W	9	72	156		
850 VA/595W*	6	59	124		
1000 VA/700W*	5	48	104		

* Runtimes do not apply for 700 VA models.

1250–2000 VA Models					
Load	UPS Internal Batteries	+1 EBM	+2 EBMs	+3 EBMs	+4 EBMs
400 VA/280W	46	177	331	501	682
700 VA/490W	25	96	180	272	370
850 VA/595W	21	76	142	214	292
1000 VA/700W	16	61	115	174	237
1250 VA/875W	11	46	87	131	179
1500 VA/1050W**	8	37	70	106	144
1800 VA/1260W***	6	30	57	85	116
2000 VA/1400W***	5	26	49	74	100

** Runtimes do not apply for 1250 VA models.

*** Runtimes do not apply for 1250 VA and 1500 VA models.

NOTE Battery times are approximate and vary depending on the load configuration and battery charge.

Chapter 9 Troubleshooting

This section explains:

- UPS alarms and conditions
- How to silence an alarm
- Service and support

Audible Alarms and UPS Conditions

The UPS has an audible alarm feature to alert you of potential power problems. Use Table 10 to determine and resolve the UPS alarms and conditions.



NOTE Some alarms, such as the *Overtemperature* and *Overload* alarms, must be cleared by shutting down and restarting the UPS (see page 59 for more information).

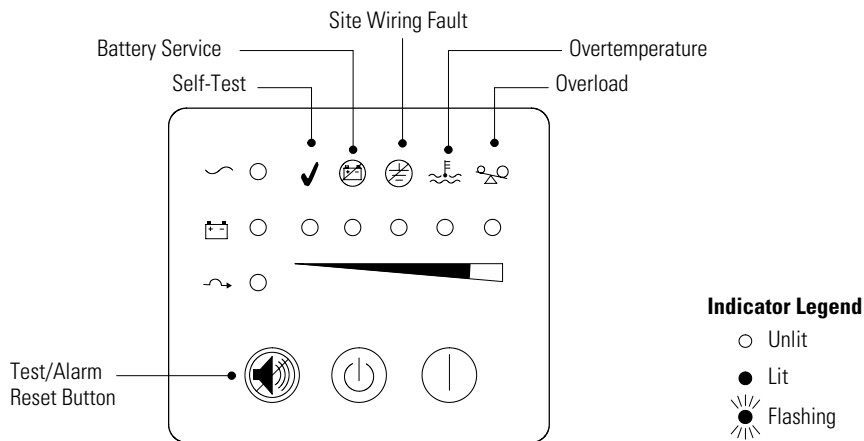











Figure 33. Alarm Indicators











Silencing an Audible Alarm



Before silencing an alarm, check the alarm condition and perform the applicable action to resolve the condition (see Table 10).

To silence the alarm for an existing fault, press the button. If UPS status changes, the alarm beeps, overriding the previous alarm silencing.

Table 10. Troubleshooting Guide

Alarm or Condition	Possible Cause	Action
The  indicator is not on; the UPS does not start.	The power cord is not connected correctly.	Check the power cord connections.
	The wall outlet is faulty.	Have a qualified electrician test and repair the outlet.
	The remote emergency power-off (REPO) switch is active.	Reset the REPO switch and restart the UPS.
The  indicator is flashing; power is not available at the UPS output receptacles.	The UPS is in Standby mode.	Press the On button to supply power to the connected equipment.
The UPS operates normally, but some or all of the protected equipment is not on.	The equipment is not connected to the UPS correctly.	Verify that the equipment is plugged into the UPS receptacles.
	The output receptacle circuit breaker (2000 VA only) is open.	Check the load. Disconnect faulty load equipment. Wait several minutes before resetting the UPS circuit breaker.
	One of the load segments has been turned off through the power management software.	Reactivate the segment with the software.
Output circuit breaker trips (2000 VA only).	Load fault.	Check the load. Disconnect faulty load equipment. Wait several minutes before resetting the UPS circuit breaker.
The UPS does not provide the expected backup time.	The battery needs charging or service.	Plug the UPS into a power outlet for 36 hours to charge the battery. After charging the battery, press and hold the  button for 3 seconds; then check the  indicator. If the  indicator is still flashing, see "Replacing Batteries" on page 48.
 ● Battery Intermittent audible alarm	The UPS is on battery (see "Battery Mode" on page 35 for more information).	The UPS is powering the equipment with battery power. Check the bar graph indicators for available battery capacity and prepare your equipment for shutdown.
 ● ●  ○ ○ ○  Warning - Low Battery	Low Battery warning.	This warning is approximate, and the actual time to the Shutdown Imminent warning may vary significantly. Depending on the UPS load and number of Extended Battery Modules (EBMs), the Low Battery warning may occur before the batteries reach 25% capacity. See Table 9 on page 56 for estimated runtimes.

Alarm or Condition	Possible Cause	Action
 Shutdown - Low Battery	Shutdown imminent.	Prepare for a shutdown. Save your work and turn off your equipment.
 Bypass	The UPS is in Bypass mode.	The equipment is transferred to utility power; however, the utility power continues to be passively filtered by the UPS. Check for one of the following alarms: Overtemperature, Overload, or Battery Service.
 Bypass	Bypass is not available. Input voltage is not within $\pm 12\%$ of nominal or input frequency is not within $\pm 3\%$ of nominal.	The UPS is receiving utility power that may be unstable or in brownout conditions. The UPS continues to supply power to your equipment. If conditions worsen, the UPS may switch to battery power.
 Battery Service	The battery may be fully discharged. The battery is not connected correctly.	Plug the UPS into a power outlet for 36 hours to charge the battery. After charging the battery, press and hold the  button for 3 seconds; then check the  indicator. If the  indicator is still flashing, see "Replacing Batteries" on page 48. Check the battery connections. Call your service representative if the problem persists.
 Site Wiring Fault (120V models only)	Ground wire connection does not exist or the line and neutral wires are reversed in the wall outlet.	Have a qualified electrician correct the wiring. To disable this alarm, see "Configuration" on page 37.
 Overtemperature	UPS internal temperature is too high. The UPS transfers to Bypass mode, allowing the UPS to cool.	Turn off and unplug the UPS. Clear vents and remove any heat sources. Ensure the airflow around the UPS is not restricted. Wait at least five minutes and restart the UPS. If the condition persists, contact your service representative.
 Overload Continuous audible alarm	Power requirements exceed UPS capacity (101–110% for 2 minutes or 111–150% for 30 seconds) or the load is defective.	Turn off and unplug the UPS. Remove some of the equipment from the UPS. Wait at least five seconds until all LEDs are off and restart the UPS. You may need to obtain a larger capacity UPS.

Alarm or Condition	Possible Cause	Action
 Self-Test 	The self-test has not completed properly.	Verify that the proper amount of load is applied to the UPS before starting the self-test: 50% load for 700 VA; 35% load for 1000 VA; 45% load for 1250 VA; 38% load for 1500 VA; or 25% load for 2000 VA.
	UPS fault condition.	Save your work and turn off your equipment. Turn off and unplug the UPS. Contact your service representative. The alarm cannot be silenced.

Service and Support

If you have any questions or problems with the UPS, call your **Local Distributor** or the **Help Desk** at one of the following telephone numbers and ask for a UPS technical representative.

United States: **1-800-356-5737** or **1-919-870-3149**
 Canada: **1-800-461-9166 ext 260**
 All other countries: **Call your local service representative**

Please have the following information ready when you call the Help Desk:

- Model number
- Serial number
- Version number (if available)
- Date of failure or problem
- Symptoms of failure or problem
- Customer return address and contact information

If repair is required, you will be given a Returned Material Authorization (RMA) Number. This number must appear on the outside of the package and on the Bill Of Lading (if applicable). Use the original packaging or request packaging from the Help Desk or distributor. Units damaged in shipment as a result of improper packaging are not covered under warranty. A replacement or repair unit will be shipped, freight prepaid for all warrantied units.



NOTE For critical applications, immediate replacement may be available. Call the **Help Desk** for the dealer or distributor nearest you.

Chapter 10 Warranty

Two-Year Limited Warranty (US and Canada)

Powerware UPS Models: 3105, 3110, 3115, 9104, 9120, 9125, 9140, and FERRUPS® up to 3.1 kVA

WARRANTOR: The warrantor for the limited warranties set forth herein is Eaton Electrical Inc., a Delaware Corporation company ("Company").

LIMITED WARRANTY: This limited warranty (this "Warranty") applies only to the original End-User (the "End-User") of any Powerware 3105, 3110, 3115, 9104, 9120, 9125, 9140, and FERRUPS up to 3.1 kVA Products (individually and collectively, the "Product") purchased on or after June 1, 2004 and cannot be transferred. This Warranty applies even in the event that the Product is initially sold by Company for resale to an End-User.

LIMITED WARRANTY PERIOD: The period covered by this Warranty for Product installed [and currently located] in the fifty (50) United States, the District of Columbia, and Canada is twenty-four (24) months from the date of purchase.

WHAT THIS LIMITED WARRANTY COVERS: The warrantor warrants that the Product and battery (individually and collectively, the "Warranted Items") are free from defects in material and workmanship. If, in the opinion of Company, a Warranted Item is defective and the defect is within the terms of this Warranty, Company's sole obligation will be to repair or replace such defective Warranted Item (including by providing service, parts and labor, as applicable), at the option of Company.

PROCEDURES FOR REPAIR OR REPLACEMENT OF WARRANTED ITEMS: The Warranted Item will be repaired or replaced at a Company site or such other location as determined by Company.

If the Warranted Item is to be replaced by Company, and the End-User supplies a credit card number or purchase order for the value of the replacement Product, Company will use commercially reasonable business efforts to ship (via standard ground shipment and at no cost to the End-User) the replacement Warranted Item to the End-User within one (1) business day after Company receives notice of the warranty claim. In such case, the End-User must return (at Company's expense) the defective Warranted Item to Company in the same packaging as the replacement Warranted Item received by the End-User or as otherwise instructed by Company. If Company does not receive the defective Warranted Item, Company will either charge the End-User's credit card, or send the End-User an invoice (which the End-User agrees to pay), for the value of the replacement Product.

If the Warranted Item is to be replaced by Company, but the End-User is unwilling or unable to supply a credit card number or purchase order for the value of the replacement Product, Company will use commercially reasonable business efforts to ship (via standard ground shipment and at no cost to the End-User) the replacement Warranted Item to the End-User within one (1) business day after Company receives the defective Product from the End-User.

In any case, Company will provide shipping instructions and will pay its designated carrier for all shipping charges for return of defective equipment and replacement of Warranted Items. Any returned Warranted Item or parts that are replaced may be new or reconditioned. All Warranted Items returned to Company and all parts replaced by Company shall become the property of Company.

WHAT THIS LIMITED WARRANTY DOES NOT COVER: This Warranty does not cover any defects or damages caused by: (a) failure to properly store the Product before installation, including the charge of batteries no later than the date indicated on the packaging; (b) shipping and delivery of the Product if shipping is FOB Factory; (c) neglect, accident, abuse, misuse, misapplication, or incorrect installation; (d) repair or alteration not authorized in writing by Company personnel or performed by an authorized Company Customer Service Engineer or Agent; (e) improper testing, operation, maintenance, adjustment, or modification of any kind not authorized in writing by Company personnel or performed by an authorized Company Customer Service Engineer or Agent; or (f) use of the Product under other than normal operating conditions or in a manner inconsistent with the Product's labels or instructions.

This Warranty is not valid if the Product's serial numbers have been removed or are illegible. Any Warranted Items repaired or replaced pursuant to this Warranty will be warranted for the remaining portion of the original Warranty subject to all the terms thereof.

Company shall not be responsible for any charges for testing, checking, removal or installation of Warranted Items.

COMPANY DOES NOT WARRANT EQUIPMENT NOT MANUFACTURED BY COMPANY. IF PERMITTED BY THE APPLICABLE MANUFACTURER, COMPANY SHALL PASS THROUGH SUCH MANUFACTURER'S WARRANTIES TO END-USER.

COMPANY DOES NOT WARRANT SOFTWARE, INCLUDING SOFTWARE EMBEDDED IN PRODUCTS, THAT IS NOT CREATED BY COMPANY. WITHOUT LIMITING THE FOREGOING, COMPANY SPECIFICALLY DOES NOT WARRANT SOFTWARE (SUCH AS LINUX) THAT WAS CREATED USING AN "OPEN SOURCE" MODEL OR IS DISTRIBUTED PURSUANT TO AN OPEN SOURCE LICENSE.

THIS WARRANTY IS THE SOLE AND EXCLUSIVE WARRANTY OFFERED BY COMPANY WITH RESPECT TO THE PRODUCTS AND SERVICES AND, EXCEPT FOR SUCH FOREGOING WARRANTY COMPANY DISCLAIMS ALL OTHER WARRANTIES INCLUDING BUT NOT LIMITED TO ANY IMPLIED WARRANTIES OF MERCHANTABILITY, TITLE, NON-INFRINGEMENT, AND FITNESS FOR A PARTICULAR PURPOSE. CORRECTION OF NON-CONFORMITIES IN THE MANNER AND FOR THE PERIOD OF TIME PROVIDED ABOVE SHALL CONSTITUTE COMPANY'S SOLE LIABILITY AND END-USER'S EXCLUSIVE REMEDY FOR FAILURE OF COMPANY TO MEET ITS WARRANTY OBLIGATIONS, WHETHER CLAIMS OF THE END-USER ARE BASED IN CONTRACT, IN TORT (INCLUDING NEGLIGENCE OR STRICT LIABILITY), OR OTHERWISE.

LIMITATION OF LIABILITY: The remedies of the End-User set forth herein are exclusive and are the sole remedies for any failure of Company to comply with its obligations hereunder. In no event shall Company be liable in contract, in tort (including negligence or strict liability) or otherwise for damage to property or equipment other than the Products, including loss of profits or revenue, loss of use of Products, loss of data, cost of capital, claims of customers of the End-User or any special, indirect, incidental or consequential damages whatsoever. The total cumulative liability of Company hereunder whether the claims are based in contract (including indemnity), in tort (including negligence or strict liability) or otherwise, shall not exceed the price of the Product on which such liability is based.

Company shall not be responsible for failure to provide service or parts due to causes beyond Company's reasonable control.

END-USER'S OBLIGATIONS: In order to receive the benefits of this Warranty, the End-User must use the Product in a normal way; follow the Product's user's guide; and protect against further damage to the Product if there is a covered defect.

OTHER LIMITATIONS: Company's obligations under this Warranty are expressly conditioned upon receipt by Company of all payments due to it (including interest charges, if any). During such time as Company has not received payment of any amount due to it for the Product, in accordance with the contract terms under which the Product is sold, Company shall have no obligation under this Warranty. Also during such time, the period of this Warranty shall continue to run and the expiration of this Warranty shall not be extended upon payment of any overdue or unpaid amounts.

COSTS NOT RELATED TO WARRANTY: The End-User shall be invoiced for, and shall pay for, all services not expressly provided for by the terms of this Warranty, including without limitation, site calls involving an inspection that determines no corrective maintenance is required. Any costs for replacement equipment, installation, materials, freight charges, travel expenses or labor of Company representatives outside the terms of this Warranty will be borne by the End-User.

OBTAINING WARRANTY SERVICE: In the USA, call the Customer Reliability Center 7x24 at 800-356-5737. Outside of the USA, call your local Powerware product sales or service representative, or call the Customer Reliability Center in the USA at 919-870-3149. For comments or questions about this Warranty, write to the Customer Quality Representative, 3301 Spring Forest Road, Raleigh, North Carolina 27616 USA.

Ten-Year Pro-Rated Limited Warranty (US and Canada)

Powerware UPS Models: 5115, 5125, 5140, 9104, 9120, 9125, 9140, 9155, 9170+, and FERRUPS

WARRANTOR: The warrantor for the limited warranties set forth herein is Eaton Electrical Inc., a Delaware Corporation company ("Company").

LIMITED WARRANTY: This pro-rated limited warranty (this "Warranty") applies only to the original End-User (the "End-User") of any Powerware 5115, 5125, 5140, 9104, 9120, 9125, 9140, 9155, 9170+, and FERRUPS Products (individually and collectively, the "Product") and cannot be transferred. This Warranty applies even in the event that the Product is initially sold by Company for resale to an End-User.

WHAT THIS WARRANTY COVERS: In addition to the standard Two-Year Limited Warranty covering the applicable Product, the warrantor warrants that the Product will have a service life (defined below) of ten years from the date of purchase (the "Ten-Year Service Life") when used in accordance with the storage, handling, installation, operation and maintenance procedures prescribed in the Product's user's guide. "Service life" means the Product's ability to deliver at least 80% of its original rated backup time.

If Company finds, in its sole discretion, that any Product has not provided the Ten-Year Service Life, Company will, as its sole obligation and the End-User's sole remedy for Company's breach of this warranty, repair or replace the Product, at its option, F.O.B. Company's factory, for a charge, payable by the End-User to Company pro-rated on the following basis:

The End-User will be allowed a credit against Company's list price of equivalent equipment at the time of return of the Product to Company, in proportion to the percentage of Ten-Year Service Life remaining at the time of return of the Product to Company. In calculating the available credit, the remaining portion of the Ten-Year Service Life will be rounded up or down to the nearest whole year. The End-User will assume responsibility to pay the balance of the list price; and Company reserves the right to require payment prior to delivery of the repaired or replacement equipment.

For the avoidance of doubt, Company's responsibilities under this Warranty are as follows:

- Years 1-2 - Product repaired or replaced pursuant to terms of Limited Warranty
- Years 3-10 - Unit Credit (\$) = Current List Price \times $\frac{\text{Years of Unexpired Life}}{10 \text{ Years of Warranted Life}}$

WHAT THIS LIMITED WARRANTY DOES NOT COVER: This Warranty does not cover any defects or damages caused by: (a) failure to properly store the Product before installation, including the charge of batteries no later than the date indicated on the packaging; (b) shipping and delivery of the Product if shipping is FOB Factory; (c) neglect, accident, abuse, misuse, misapplication, or incorrect installation; (d) repair or alteration not authorized in writing by Company personnel or performed by an authorized Company Customer Service Engineer or Agent; (e) improper testing, operation, maintenance, adjustment, or modification of any kind not authorized in writing by Company personnel or performed by an authorized Company Customer Service Engineer or Agent; or (f) use of the Product under other than normal operating conditions or in a manner inconsistent with the Product's labels or instructions.

This Warranty is not valid: (a) unless the End-User returns to Company the Warranty Registration Card within thirty (30) days of purchase; or (b) if the Product's serial numbers have been removed or are illegible. Any Warranted Items repaired or replaced pursuant to this Warranty will be warranted for the remaining portion of the original Warranty subject to all the terms thereof.

Company shall not be responsible for any charges for testing, checking, removal or installation of Warranted Items.

COMPANY DOES NOT WARRANT EQUIPMENT NOT MANUFACTURED BY COMPANY. IF PERMITTED BY THE APPLICABLE MANUFACTURER, COMPANY SHALL PASS THROUGH SUCH MANUFACTURER'S WARRANTIES TO END-USER.

COMPANY DOES NOT WARRANT SOFTWARE, INCLUDING SOFTWARE EMBEDDED IN PRODUCTS, THAT IS NOT CREATED BY COMPANY. WITHOUT LIMITING THE FOREGOING, COMPANY SPECIFICALLY DOES NOT WARRANT SOFTWARE (SUCH AS LINUX) THAT WAS CREATED USING AN "OPEN SOURCE" MODEL OR IS DISTRIBUTED PURSUANT TO AN OPEN SOURCE LICENSE.

THIS WARRANTY IS THE SOLE AND EXCLUSIVE WARRANTY OFFERED BY COMPANY WITH RESPECT TO THE PRODUCTS AND SERVICES AND, EXCEPT FOR SUCH FOREGOING WARRANTY COMPANY DISCLAIMS ALL OTHER WARRANTIES INCLUDING BUT NOT LIMITED TO ANY IMPLIED WARRANTIES OF MERCHANTABILITY, TITLE, NON-INFRINGEMENT, AND FITNESS FOR A PARTICULAR PURPOSE. CORRECTION OF NON-CONFORMITIES IN THE MANNER AND FOR THE PERIOD OF TIME PROVIDED ABOVE SHALL CONSTITUTE COMPANY'S SOLE LIABILITY AND END-USER'S EXCLUSIVE REMEDY FOR FAILURE OF COMPANY TO MEET ITS WARRANTY OBLIGATIONS, WHETHER CLAIMS OF THE END-USER ARE BASED IN CONTRACT, IN TORT (INCLUDING NEGLIGENCE OR STRICT LIABILITY), OR OTHERWISE.

LIMITATION OF LIABILITY: The remedies of the End-User set forth herein are exclusive and are the sole remedies for any failure of Company to comply with its obligations hereunder. In no event shall Company be liable in contract, in tort (including negligence or strict liability) or otherwise for damage to property or equipment other than the Products, including loss of profits or revenue, loss of use of Products, loss of data, cost of capital, claims of customers of the End-User or any special, indirect, incidental or consequential damages whatsoever. The total cumulative liability of Company hereunder whether the claims are based in contract (including indemnity), in tort (including negligence or strict liability) or otherwise, shall not exceed the price of the Product on which such liability is based.

Company shall not be responsible for failure to provide service or parts due to causes beyond Company's reasonable control.

END-USER'S OBLIGATIONS: In order to receive the benefits of this Warranty, the End-User must use the Product in a normal way; follow the Product's operation and maintenance manual; and protect against further damage to the Product if there is a covered defect.

OTHER LIMITATIONS: Company's obligations under this Warranty are expressly conditioned upon receipt by Company of all payments due to it (including interest charges, if any). During such time as Company has not received payment of any amount due to it for the Product, in accordance with the contract terms under which the Product is sold, Company shall have no obligation under this Warranty. Also during such time, the period of this Warranty shall continue to run and the expiration of this Warranty shall not be extended upon payment of any overdue or unpaid amounts.

COSTS NOT RELATED TO WARRANTY: The End-User shall be invoiced for, and shall pay for, all services not expressly provided for by the terms of this Warranty, including without limitation, site calls involving an inspection that determines no corrective maintenance is required. Any costs for replacement equipment, installation, materials, freight charges, travel expenses or labor of Company representatives outside the terms of this Warranty will be borne by the End-User.

OBTAINING WARRANTY SERVICE: In the USA, call the Customer Reliability Center 7x24 at 800-356-5737. Outside of the USA, contact your local Powerware product sales or service representative, or call the Customer Reliability Center in the USA at 919-870-3149. Company will not accept any Product for return, credit or exchange unless expressly authorized by Company in writing and delivered FOB Company factory. For comments or questions about this Warranty, write to the Customer Quality Representative, 3301 Spring Forest Road, Raleigh, North Carolina 27616 USA.

Load Protection Guarantee (US and Canada)

Powerware UPS Models 3105, 3110, 3115, 5110, 5115, 5125, 9120, 9125, 9140, 9150, 9155, 9170+, and FERRUPS

GUARANTOR: The Guarantor for the load protection guaranty set forth herein is Eaton Electrical Inc., a Delaware Corporation company ("Company").

LIMITED GUARANTY: This load protection guaranty (this "Guaranty") applies only to the original End-User (the "End-User") of any Powerware 3105, 3110, 3115, 5110, 5115, 5125, 9120, 9125, 9140, 9150, 9155, 9170+, and FERRUPS Products (individually and collectively, the "Product") and cannot be transferred. This Guaranty applies even in the event that the Product is initially sold by Company for resale to an End-User.

WHAT THIS GUARANTY COVERS: For the lifetime of the Product, Guarantor promises to repair or replace, at Guarantor's option, the equipment (valued up to the limits shown below*) that is damaged by an AC power line surge, spike, or other transient when properly connected to Guarantor's uninterruptible power system ("UPS"). Reimbursement for or restoration of data loss excluded. This Guaranty applies only if all of the following circumstances arise:

1. The UPS is plugged into properly grounded and wired outlets, using no extension cords, adapters, other ground wires or other electrical connectors;
2. The installation of the UPS complies with all applicable electrical and safety codes described by the National Electric Code (NEC);
3. The UPS was used under normal operating conditions and in accordance with all labels and instructions; and
4. The UPS was not damaged by accident (other than AC power line transient), misuse, or abuse.

***Cumulative Limits to be paid by Guarantor under this Load Protection Guaranty:**

- \$25,000 for Powerware UPS Models 3105, 3110, and 3115
- \$150,000 for Powerware UPS Models 5110, 5115, and 5125
- \$250,000 for Powerware UPS Models 9120, 9125, 9140, 9150, 9155, 9170+, and FERRUPS products

WHAT THIS GUARANTY DOES NOT COVER: Any reimbursement or repair to End-User's equipment does not include reimbursement for or restoration of any data loss. This Guaranty does not cover any defects or damages caused by: (a) failure to properly store the Product before installation, including the charge of batteries no later than the date indicated on the packaging; (b) shipping and delivery of the Product if shipping is FOB Factory; (c) neglect, accident, abuse, misuse, misapplication, or incorrect installation of Product; (d) repair or alteration of Product not authorized in writing by Company personnel or performed by an authorized Company Customer Service Engineer or Agent; (e) improper testing, operation, maintenance, adjustment, or modification of any kind to the Product not authorized in writing by Company personnel or performed by an authorized Company Customer Service Engineer or Agent; or (f) use of the Product under other than normal operating conditions or in a manner inconsistent with the Product's labels or instructions.

This Guaranty is not valid: (a) unless the End-User returns to Company the Warranty Registration Card within thirty (30) days of purchase; or (b) if the Product's serial numbers have been removed or are illegible.

Company shall not be responsible for any charges for testing, checking, removal or installation of any items.

LIMITATION OF LIABILITY: THE REMEDIES OF THE END-USER SET FORTH HEREIN ARE EXCLUSIVE AND ARE THE SOLE REMEDIES FOR ANY FAILURE OF COMPANY TO COMPLY WITH ITS OBLIGATIONS HEREUNDER. EXCEPT AS OTHERWISE PROVIDED FOR IN THIS GUARANTY, IN NO EVENT SHALL COMPANY BE LIABLE IN CONTRACT, IN TORT (INCLUDING NEGLIGENCE OR STRICT LIABILITY) OR OTHERWISE FOR DAMAGE TO PROPERTY OR EQUIPMENT OTHER THAN THE PRODUCTS, INCLUDING LOSS OF PROFITS OR REVENUE, LOSS OF USE OF PRODUCTS, LOSS OF DATA, COST OF CAPITAL, CLAIMS OF CUSTOMERS OF THE END-USER OR ANY SPECIAL, INDIRECT, INCIDENTAL OR CONSEQUENTIAL DAMAGES WHATSOEVER. THE TOTAL CUMULATIVE LIABILITY OF COMPANY HEREUNDER WHETHER THE CLAIMS ARE BASED IN CONTRACT (INCLUDING INDEMNITY), IN TORT (INCLUDING NEGLIGENCE OR STRICT LIABILITY) OR OTHERWISE, SHALL NOT EXCEED THOSE SET FORTH ABOVE.

Company shall not be responsible for failure to provide repair or replacement under this Guaranty due to causes beyond Company's reasonable control.

END-USER'S OBLIGATIONS: In order to receive the benefits of this Guaranty, the End-User must use the Product in a normal way; follow the Product's operation and maintenance manual; and protect against further damage to the Product if there is a covered defect.

OTHER LIMITATIONS: Company's obligations under this Guaranty are expressly conditioned upon receipt by Company of all payments due to it (including interest charges, if any). During such time as Company has not received payment of any amount due to it for the Product, in accordance with the contract terms under which the Product is sold, Company shall have no obligation under this Guaranty.

COSTS NOT RELATED TO GUARANTY: The End-User shall be invoiced for, and shall pay for, all services not expressly provided for by the terms of this Guaranty, including without limitation, site calls involving an inspection that determines no corrective maintenance is required. Any costs for replacement equipment, installation, materials, freight charges, travel expenses or labor of Company representatives outside the terms of this Guaranty will be borne by the End-User.

TO MAKE A CLAIM: In the USA, call the Customer Reliability Center 7x24 at 800-356-5737. Outside of the USA, contact your local Powerware product sales or service representative, or call the Customer Reliability Center in the USA at 919-870-3149. For comments or questions about this Load Protection Guaranty, write to the Customer Quality Representative, 3301 Spring Forest Road, Raleigh, North Carolina 27616 USA.